

Privia

PX-3s

USER'S GUIDE

GUÍA DEL USUARIO

Please keep all information for future reference.
Guarde toda documentación para futuras consultas.

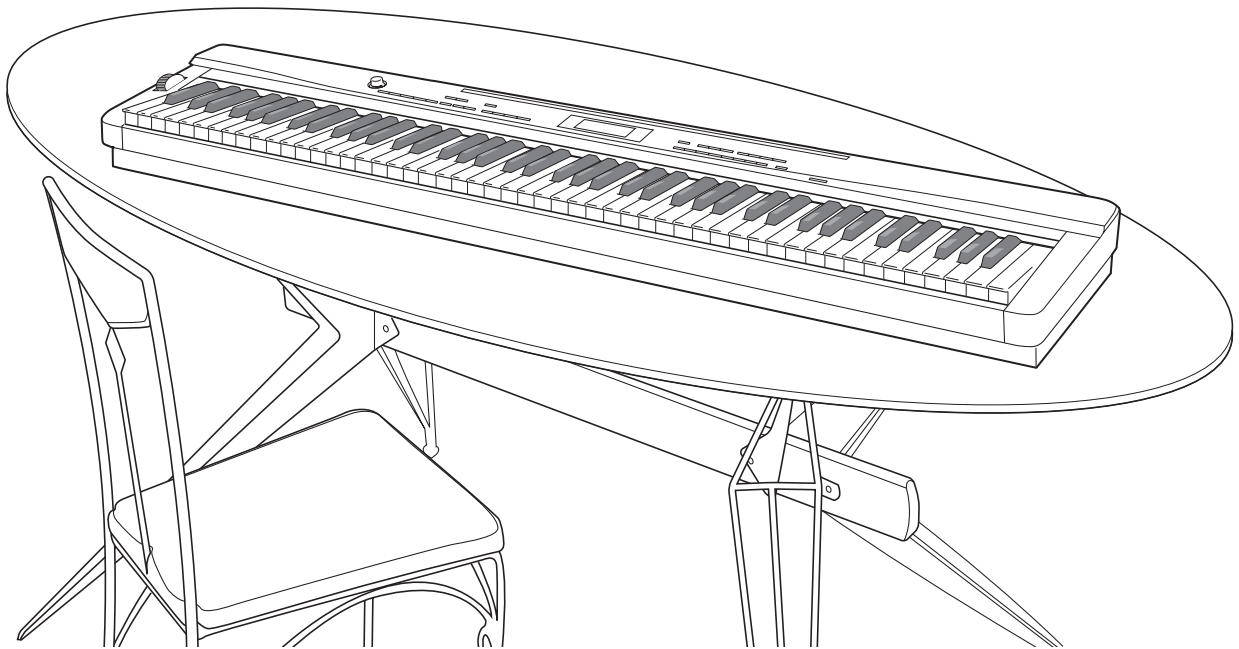
**Safety Precautions**

Before trying to use the piano, be sure to read the separate "Safety Precautions".

Precauciones de seguridad

Antes de intentar usar el piano, asegúrese de leer las "Precauciones de seguridad" separadas.

IMPORTANT SAFETY INSTRUCTIONS

1. Read these instructions.
2. Keep these instructions.
3. Heed all warnings.
4. Follow all instructions.
5. Do not use this apparatus near water.
6. Clean only with dry cloth.
7. Do not block any ventilation openings. Install in accordance with the manufacturer's instructions.
8. Do not install near any heat sources such as radiators, heat registers, stoves, or other apparatus (including amplifiers) that produce heat.
9. Do not defeat the safety purpose of the polarized or grounding-type plug. A polarized plug has two blades with one wider than the other. A grounding type plug has two blades and a third grounding prong. The wide blade or the third prong are provided for your safety. If the provided plug does not fit into your outlet, consult an electrician for replacement of the obsolete outlet.
10. Protect the power cord from being walked on or pinched particularly at plugs, convenience receptacles, and the point where they exit from the apparatus.
11. Only use attachments/accessories specified by the manufacturer.
12. Use only with the cart, stand, tripod, bracket, or table specified by the manufacturer, or sold with the apparatus. When a cart is used, use caution when moving the cart/apparatus combination to avoid injury from tip-over.
13. Unplug this apparatus during lightning storms or when unused for long periods of time.
14. Refer all servicing to qualified service personnel. Servicing is required when the apparatus has been damaged in any way, such as power-supply cord or plug is damaged, liquid has been spilled or objects have fallen into the apparatus, the apparatus has been exposed to rain or moisture, does not operate normally, or has been dropped.



The apparatus shall not be exposed to dripping or splashing and that no objects filled with liquids, such as vases, shall be placed on the apparatus.

The power indicator being unlit does not mean the apparatus is completely disconnected from the MAINS. When you need to have the apparatus completely disconnected from the MAINS, you must unplug the power cord. For that purpose, locate the apparatus in a way that secures easy access to the power cord.

Declaration of Conformity

Model Number: PX-3S
Trade Name: CASIO COMPUTER CO., LTD.
Responsible party: CASIO AMERICA, INC.
Address: 570 MT. PLEASANT AVENUE, DOVER, NEW JERSEY 07801
Telephone number: 973-361-5400

This device complies with Part 15 of the FCC Rules, Operation is subject to the following two conditions:

(1) This device may not cause harmful interference, and (2) this device must accept any interference received, including interference that may cause undesired operation.

NOTICE

This equipment has been tested and found to comply with the limits for a Class B digital device, pursuant to Part 15 of the FCC Rules. These limits are designed to provide reasonable protection against harmful interference in a residential installation. This equipment generates, uses and can radiate radio frequency energy and, if not installed and used in accordance with the instructions, may cause harmful interference to radio communications. However, there is no guarantee that interference will not occur in a particular installation. If this equipment does cause harmful interference to radio or television reception, which can be determined by turning the equipment off and on, the user is encouraged to try to correct the interference by one or more of the following measures:

- Reorient or relocate the receiving antenna.
- Increase the separation between the equipment and receiver.
- Connect the equipment into an outlet on a circuit different from that to which the receiver is connected.
- Consult the dealer or an experienced radio/TV technician for help.

FCC WARNING

Changes or modifications not expressly approved by the party responsible for compliance could void the user's authority to operate the equipment.

Important!

Please note the following important information before using this product.

- Before using the AD-A12150LW Adaptor to power the product, be sure to check the AC Adaptor for any damage first. Carefully check the power cord for breakage, cuts, exposed wire and other serious damage. Never let children use an AC adaptor that is seriously damaged.
- The product is not intended for children under 3 years.
- Use only the CASIO AD-A12150LW adaptor.
- The AC adaptor is not a toy.
- Be sure to disconnect the AC adaptor before cleaning the product.



This mark applies in EU countries only.



Manufacturer:
CASIO COMPUTER CO., LTD.
6-2, Hon-machi 1-chome, Shibuya-ku, Tokyo 151-8543, Japan

Responsible within the European Union:
CASIO EUROPE GmbH
Casio-Platz 1, 22848 Norderstedt, Germany

Contents

General Guide..... E-2

- Installing the Music Stand E-3
- PX-3S Configuration E-4
- Modes E-6
- Saving Settings and Using Panel Lock..... E-7
- Returning the Digital Piano to Its
Factory Default Settings E-7

Power Outlet E-8

- Using an AC Adaptor E-8

Connections..... E-9

- Connecting Headphones E-9
- Connecting a Pedal E-9
- Connecting Audio Equipment or an Amplifier E-10
- Bundled and Optional Accessories..... E-10

Selecting and Playing a Tone..... E-11

- To turn on Digital Piano Power E-11
- Listening to Demo Tunes E-11
- Selecting a Tone E-11
- Layering and Splitting Tones E-12

Applying Effects to a Tone.... E-17

- Reverb and Chorus..... E-17
- Pitch Bend Wheel E-17

Confirming Common Parameter Settings..... E-18

- Common Parameters Operations E-18
- Common Parameter Settings E-20

Using the Assignable Buttons..... E-24

- Applying Modulation to Notes (ASSIGNABLE 1)..... E-24
- Applying Portamento to Notes (ASSIGNABLE 1/2) ... E-24
- Changing the Rotary Effect Speed
(ASSIGNABLE 2)..... E-24
- By-passing the DSP (ASSIGNABLE 2) E-25
- Sending Control Changes (ASSIGNABLE 1/2) E-25

Using the Digital Piano as a MIDI Master Keyboard..... E-26

- External MIDI Device Connection E-26
- Specifying the Zone Configuration..... E-26
- Specifying What Each Zone Controls E-27
- Zone Setups E-27

Editing Zone Parameters..... E-28

- Zone Parameter Operations E-28
- Zone Parameter Settings..... E-30

Using Registration Memory... E-34

- Registration Data E-34
- Registration Memory Operations E-34
- Saving Registration Memory Bank Data to a File E-36

Using the Function Menu E-38

- Function Menu Operations..... E-38
- Function Menu Settings E-39

Playing Back a MIDI File E-41

- MIDI File Playback Operations..... E-41
- Supported Operations During MIDI File Playback E-42
- Creating a New Card Music Folder E-44

Using a Memory Card E-46

- Memory Card Operations..... E-46
- Error Messages..... E-48

Connecting to a Computer E-49

- Minimum Computer System Requirements E-49
- Connecting the Digital Piano to Your Computer E-49
- Transferring Data between the
Digital Piano and a Computer E-50

Reference E-52

- Troubleshooting E-52
- Product Specifications..... E-54
- Operating Precautions E-55

Appendix E-57

- Tone List E-57
- Drum Assignment List E-59
- DSP Effect List..... E-60
- DSP Algorithm List..... E-61

MIDI Implementation Chart

Company and product names used in this manual may be registered trademarks of others.

General Guide

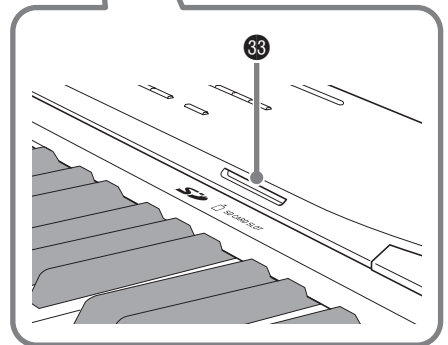
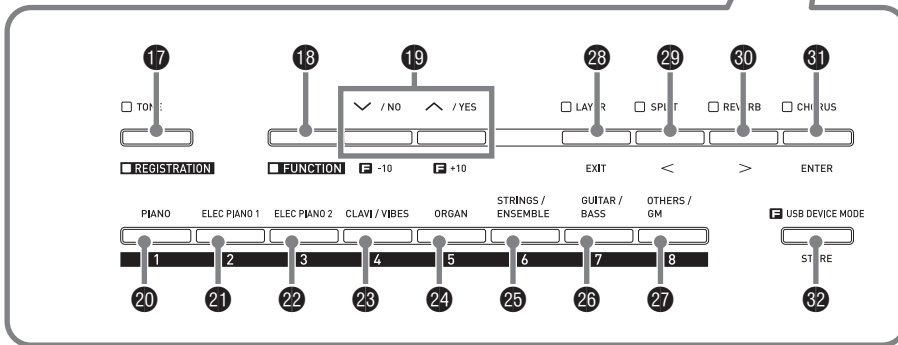
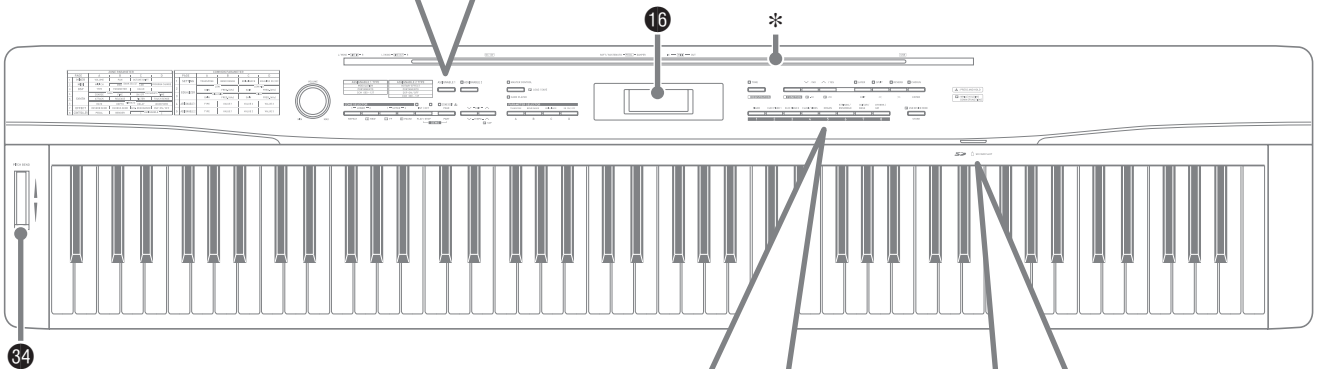
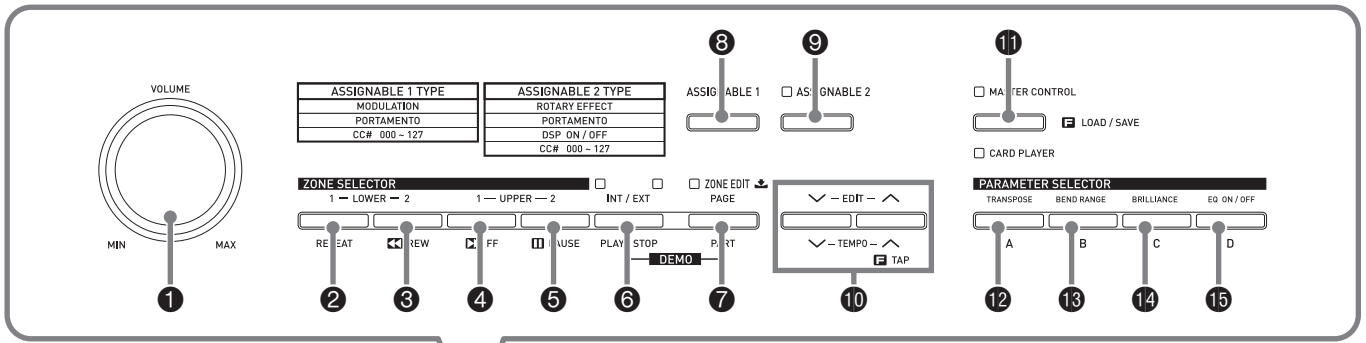

Back

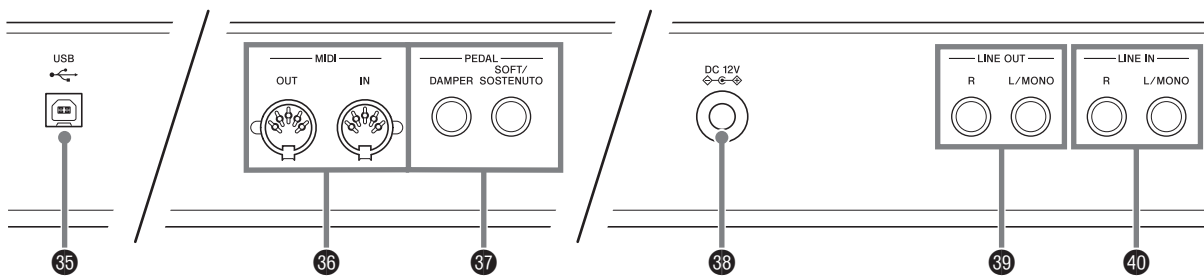

Left Side

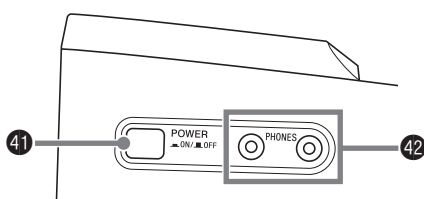

Bottom

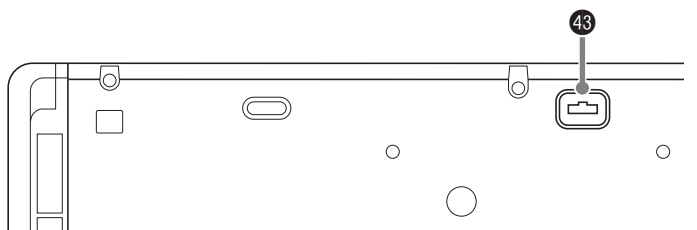

- This manual uses the numbers and names below to refer to buttons and controllers.

- ❶ **VOLUME** knob
- ❷ **ZONE SELECTOR (LOWER 1), REPEAT** button
- ❸ **ZONE SELECTOR (LOWER 2), ◀◀REW** button
- ❹ **ZONE SELECTOR (UPPER 1), ▶▶FF** button
- ❺ **ZONE SELECTOR (UPPER 2), PAUSE** button
- ❻ **INT/EXT, PLAY/STOP** button
- ❼ **ZONE EDIT, PAGE, PART** button
- ❽ **ASSIGNABLE 1** button
- ❾ **ASSIGNABLE 2** button
- ❿ **EDIT, TEMPO** button
- ⓫ **MASTER CONTROL, CARD PLAYER, LOAD/SAVE** button
- ⓬ **PARAMETER SELECTOR (TRANSPOSE, A)** button
- ⓭ **PARAMETER SELECTOR (BEND RANGE, B)** button
- ⓮ **PARAMETER SELECTOR (BRILLIANCE, C)** button
- ⓯ **PARAMETER SELECTOR (EQ ON/OFF, D)** button
- ⓰ Display
- ⓱ **TONE, REGISTRATION** button
- ⓲ **FUNCTION** button
- ⓳ **∨/NO, ∧/YES** button
- ⓴ **PIANO, 1** button
- ⓵ **ELEC PIANO 1, 2** button
- ⓶ **ELEC PIANO 2, 3** button
- ⓷ **CLAVI/VIBES, 4** button
- ⓸ **ORGAN, 5** button
- ⓹ **STRINGS/ENSEMBLE, 6** button
- ⓺ **GUITAR/BASS, 7** button
- ⓻ **OTHERS/GM, 8** button
- ⓼ **LAYER, EXIT** button
- ⓽ **SPLIT, <** button
- ⓿ **REVERB, >** button
- ⓾ **CHORUS, ENTER** button
- ⓿ **STORE, USB DEVICE MODE** button
- ⓿ **SD CARD SLOT**
- ⓿ **PITCH BEND** wheel
- ⓿ **USB** port
- ⓿ **MIDI OUT/IN** terminals
- ⓿ **DAMPER, SOFT/SOSTENUTO PEDAL** jacks
- ⓿ **DC 12V** terminal
- ⓿ **LINE OUT R, L/MONO** jacks
- ⓿ **LINE IN R, L/MONO** jacks
- ⓿ **POWER** button
- ⓿ **PHONES** jacks
- ⓿ Pedal connector

* Installing the Music Stand

Insert the bottom of the music stand into the groove on the top of the Digital Piano's console.

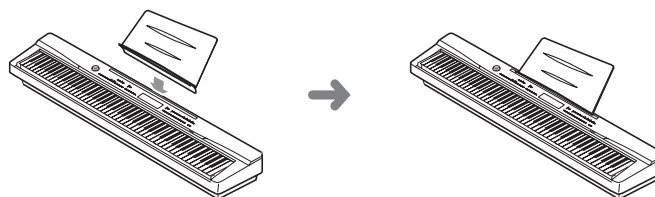

PX-3S Configuration

Master Control Configuration

The PX-3S Digital Piano is a MIDI master keyboard that uses four zones (UPPER 1, UPPER 2, LOWER 1, LOWER 2) to control the internal sound source (INT) and external MIDI devices (EXT). Each zone performs simultaneous control over one internal sound source part and one external MIDI device channel (when both INT and EXT are ON).

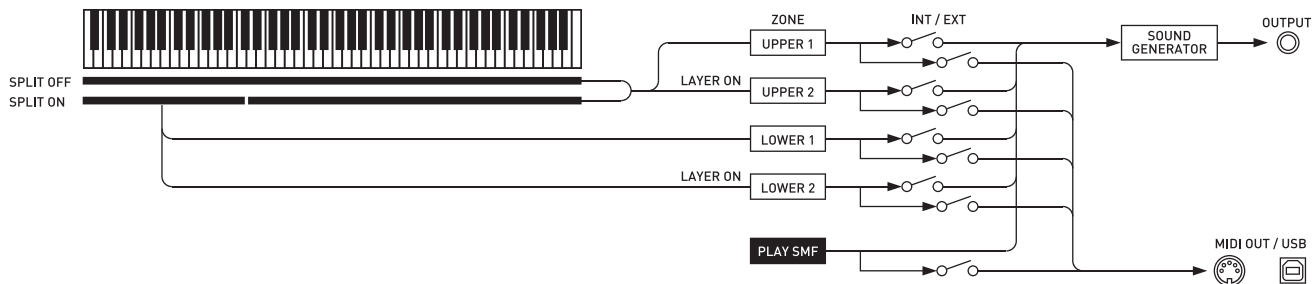

The target (INT/EXT) of each zone control can be turned on or off as desired using the **6 (INT/EXT)** button. Zone editing (page E-28) lets you configure detailed settings related to how each individual zone controls an internal sound source and/or external MIDI device.

In the case of an internal sound source, zone editing can be performed to create sounds by selecting a DSP, configuring DSP settings, editing tones, etc. Following sound creation, signals are output via an equalizer that allows adjustment of centralized common parameter settings (page E-18).

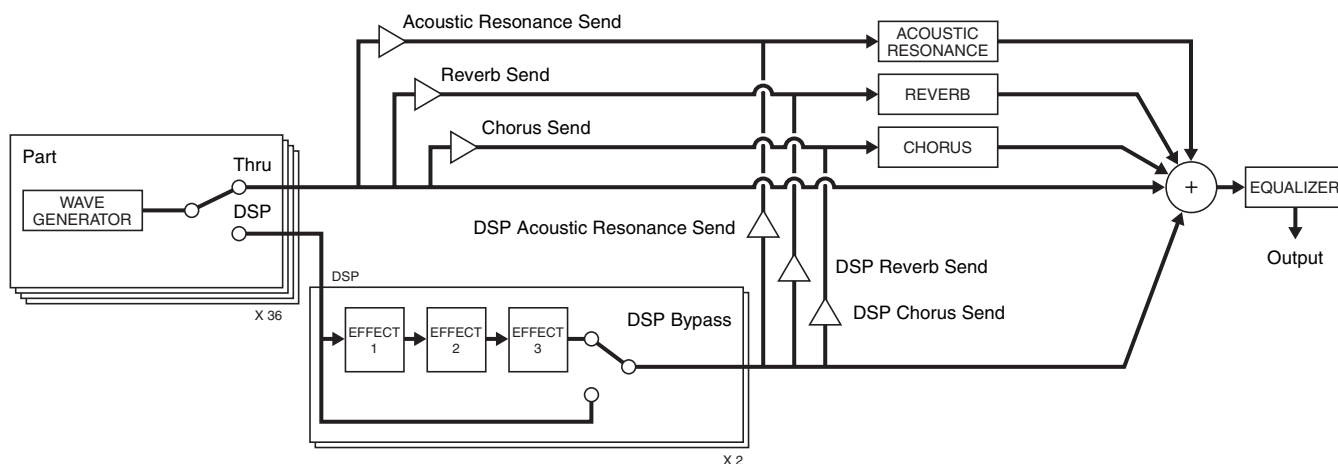

NOTE

- Which of the four zones are available for use depends on the LAYER and SPLIT on/off status. For details, see “Layering and Splitting Tones” (page E-12) and “Specifying the Zone Configuration” (page E-26).

Sound Source Configuration

The sound source is configured with a total of 36 parts: four parts that correspond to each of the zones, 16 parts for MIDI file playback, and 16 parts that operate as the multi-timbre sound source during receipt of MIDI input.

The following shows the relationships between parts, ports, and MIDI channels.

Port 0 (Parts played by hand)

Part Number	MIDI Channel	Part Name
1	IN:- - / OUT:01-16*1	Upper1
2	IN:- - / OUT:01-16*1	Upper2
3	IN:- - / OUT:01-16*1	Lower1
4	IN:- - / OUT:01-16*1	Lower2

*1 MIDI OUT channel depends on zone editing (page E-28).

Port 1 (MIDI file playback parts)

Part Number	MIDI Channel	Part Name
17	IN:- - / OUT:01	Song01
⋮	⋮	⋮
32	IN:- - / OUT:16	Song16

Port 2 (MIDI IN parts)

Part Number	MIDI Channel	Part Name
33	IN:01 / OUT:- -	Ext.01
⋮	⋮	⋮
48	IN:16 / OUT:- -	Ext.16

NOTE

- MIDI messages output from the above Port 0 and Port 1 are grouped and sent from a single MIDI port. Port-specific send is not supported.

Modes

This Digital Piano has two main modes: a MASTER CONTROL mode and a CARD PLAYER mode. Each of these modes has two sub-modes: a TONE mode and a REGISTRATION mode.

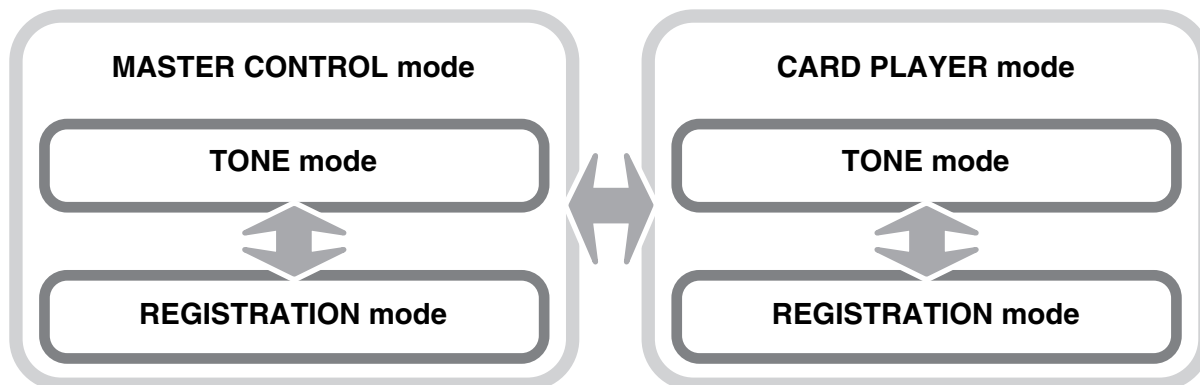

Use the MASTER CONTROL mode when playing the Digital Piano in a stand-alone configuration or when using it as a MIDI master keyboard.

The setup of the MASTER CONTROL mode can be changed using common parameters (page E-18) and zone parameters (page E-28).

Use the CARD PLAYER mode to play back a MIDI file. In the CARD PLAYER mode, you can play on the keyboard along with MIDI file playback. Though the CARD PLAYER mode also supports control of an external MIDI device, parameter settings cannot be configured.

Note that you should be aware of the Digital Piano's current mode whenever performing an operation. Note the following important points.

- The Digital Piano's initial power on default mode is the MASTER CONTROL mode's TONE mode.
- Each press of the **⏮ (MASTER CONTROL/CARD PLAYER)** button toggles between the MASTER CONTROL and CARD PLAYER modes. You can determine the current mode by noting which **⏮ (MASTER CONTROL/CARD PLAYER)** lamp is lit.

Lit in the MASTER CONTROL mode.

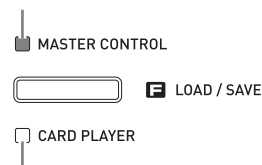

Lit in the CARD PLAYER mode.

Lit in the TONE mode.



Lit in the REGISTRATION mode.



IMPORTANT!

- All of the operations in this user's guide start from the initial power on default state (MASTER CONTROL, TONE mode). If you start experiencing operation problems, first try returning the Digital Piano to the MASTER CONTROL, TONE mode. If you do not mind losing currently unsaved settings and data, simply turn power off and then back on again.

NOTE

- The section title bars in this user's guide also show the mode (MASTER CONTROL or CARD PLAYER, or both) where the operations described in each section can be performed.

Saving Settings and Using Panel Lock

Your Digital Piano lets you save its current settings, and lock its buttons to protect against operation errors. For details, see “Backup” and “Panel Lock” (page E-40).

Returning the Digital Piano to Its Factory Default Settings

Perform the following procedure when you want to return the Digital Piano’s stored data and settings to their initial factory defaults.

1. Turn off the Digital Piano.
2. While holding down both the **17 (TONE)** and **18 (FUNCTION)** buttons, press the **41 (POWER)** button.
 - The Digital Piano will turn on and initialize its internal system. You will be able to use the Digital Piano in a short while.

NOTE

- See “To turn on Digital Piano Power” (page E-11) for information about turning Digital Piano power on and off.

Power Outlet

Your Digital Piano runs on standard household power. Be sure to turn off power whenever you are not using the Digital Piano.

Using an AC Adaptor

Use only the AC adaptor (JEITA Standard, with unified polarity plug) that comes with this Digital Piano. Use of a different type of AC adaptor can cause malfunction.

Specified AC Adaptor: AD-A12150LW

- Use the supplied power cord to connect the AC adaptor as shown in the illustration below.

Back

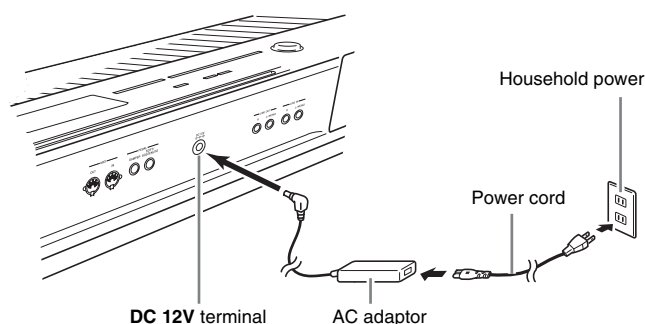

Note the following important precautions to avoid damage to the power cord.

During Use

- Never pull on the cord with excessive force.
- Never repeatedly pull on the cord.
- Never twist the cord at the base of the plug or connector.
- The power cord should not be stretched tight while it is in use.

During Movement

- Before moving the Digital Piano, be sure to unplug the AC adaptor from the power outlet.

During Storage

- Loop and bundle the power cord, but never wind it around the AC adaptor.



IMPORTANT!

- Never connect the AC adaptor (JEITA Standard, with unified polarity plug) that comes with this Digital Piano to any other device besides this piano. Doing so creates the risk of malfunction.
- Make sure the Digital Piano is turned off before plugging in or unplugging the AC adaptor.
- The AC adaptor will become warm to the touch after very long use. This is normal and does not indicate malfunction.

Connections

Connecting Headphones

IMPORTANT!

- Before connecting headphones, be sure to use the Digital Piano's **(VOLUME)** knob to turn the volume down to a low level. After connecting, you can adjust the volume to the level you want.

Left Side

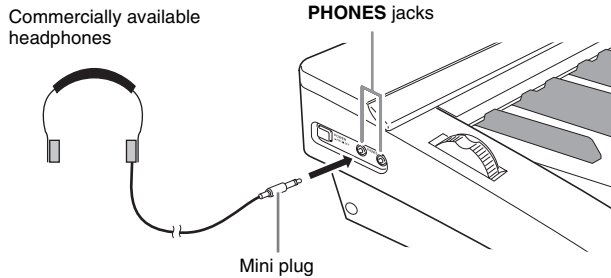

Connect commercially available headphones to the **PHONES** jacks. To protect your hearing, make sure that you do not set the volume level too high when using headphones.

Connecting a Pedal

The back of the Digital Piano has two pedal jacks, one for a damper pedal and one for a soft/sostenuto pedal.

To connect to the pedal jack

Depending on the type of operation you want the pedal (SP-3) to perform, connect the pedal's cable either to the Digital Piano's **DAMPER PEDAL** jack or **SOFT/SOSTENUTO PEDAL** jack. If you want to use both operations (jacks) at the same time, you need to purchase another optionally available pedal.

Back

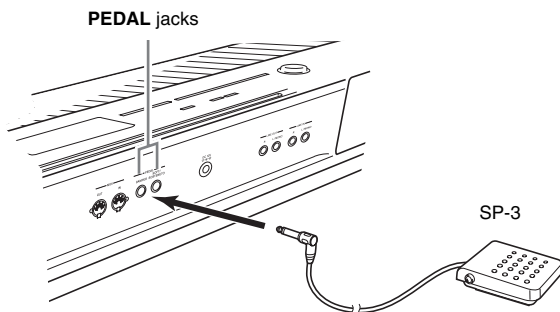

NOTE

- You can connect a pedal to the **SOFT/SOSTENUTO PEDAL** jack and apply either a soft or sostenuto effect to the notes you play. For details, see "Pedal Assign" (page E-39).

Pedal Functions

● Damper Pedal

Pressing the damper pedal while playing will cause the notes you play to reverberate for a very long time.

- Whenever a piano tone is selected, pressing this pedal will activate the Digital Piano's Acoustic Resonance effect, which causes notes to resonate in the same way they do when the damper pedal on an acoustic piano is pressed. You can adjust the acoustic resonance effect for each individual tone, and you can apply it to other non-piano tones, if you want. For details, see "Acoustic Resonance" (page E-39) and "Acoustic Resonance Send" (page E-32).

● Soft Pedal

Pressing this pedal suppresses notes played on the keyboard after the pedal was pressed, and makes them sound softer.

● Sostenuto Pedal

Only the notes that are played while this pedal are depressed are sustained until the pedal is released.

Pedal Connector

You can connect the optionally available 3-Pedal Unit (SP-32) to the pedal connector on the bottom of the Digital Piano. You can then use the pedals for expression that is similar to that available on an acoustic piano.

Bottom

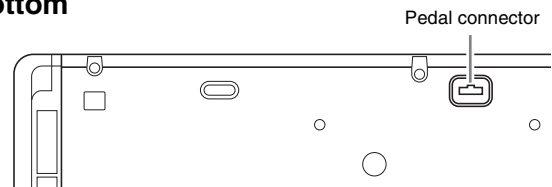

NOTE

- The SP-32 Pedal Unit supports half-pedal operation (pressing the pedal part way). You can adjust the amount of the effect is applied when the damper pedal is pressed part way. For details, see "Half Pedal Effect" (page E-39).
- The optionally available CS-67P special stand is required in order to use the SP-32 Pedal Unit.

Connecting Audio Equipment or an Amplifier

This Digital Piano outputs notes from its **LINE OUT R** (right channel output) and **LINE OUT L/MONO** (left channel output). Connect a keyboard amplifier or other device to direct output to speakers. You can adjust the **LINE OUT** volume level with the Digital Piano's ❶ (**VOLUME**) knob.

IMPORTANT!

- Whenever connecting something to the Digital Piano, first use the ❶ (**VOLUME**) knob to set the volume to a low level. After connecting, you can adjust the volume to the level you want.
- Whenever you connect any device to the Digital Piano, be sure to read the user documentation that comes with the device.

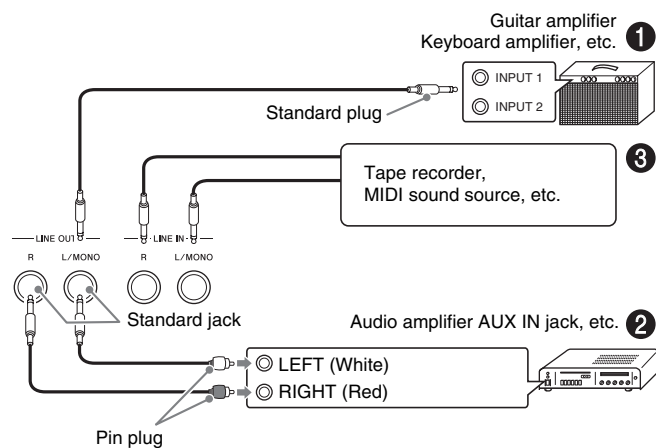

To output to a musical instrument amplifier (Figure ❶)

Use a commercially available connecting cord to connect the amplifier to the Digital Piano's **LINE OUT L/MONO** jack as shown in Figure ❶. Connecting a cord to **LINE OUT L/MONO** only will cause the left and right channels to be mixed and output as mono.

To output to audio equipment (Figure ❷)

Use commercially available connection cords to connect as shown in Figure ❷. Normally, you should set the input selector of the audio equipment to the terminal where the Digital Piano is connected (**AUX IN**, etc.).

To input from audio equipment (Figure ❸)

LINE IN R jack input is output from the **LINE OUT R** jack, and **LINE IN L/MONO** input is output from **LINE OUT L/MONO**. Use commercially available connection cords that match the equipment being connected to. Connecting a cord to **LINE IN L/MONO** only will cause the left and right channels to be mixed and output from both **LINE OUT R** and **LINE OUT L/MONO**.

NOTE

- Input from **LINE IN R** and **LINE IN L/MONO** is output as-is from **LINE OUT R** and **LINE OUT L/MONO**. The Digital Piano's ❶ (**VOLUME**) knob setting does not affect this output.

Bundled and Optional Accessories

Use only accessories that are specified for use with this Digital Piano.

Use of unauthorized accessories creates the risk of fire, electric shock, and personal injury.

NOTE

- You can get information about accessories that are sold separately for this product from the CASIO catalog available from your retailer, and from the CASIO website at the following URL.
<http://world.casio.com/>

Selecting and Playing a Tone

To turn on Digital Piano Power

1. After ensuring that the **41 (POWER)** button is in the off position, connect the AC adaptor to the Digital Piano.

Left Side

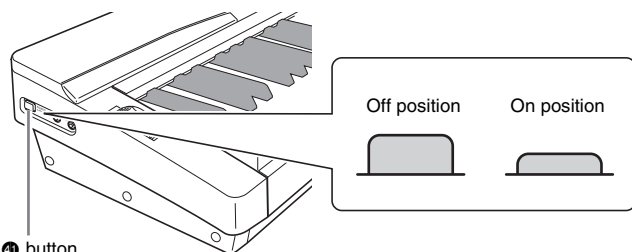

- For information about connecting the AC adaptor, see “Power Outlet” (page E-8).
2. Rotate the **1 (VOLUME)** knob towards MIN to set the volume to a low level.
 3. Connect headphones or other devices to the Digital Piano as necessary (see “Connections” on page E-9).
 4. Press the **41 (POWER)** button to turn on the Digital Piano.
 - The Digital Piano display screen will appear as shown below, which indicates that it is ready to play (using initial power on default settings).

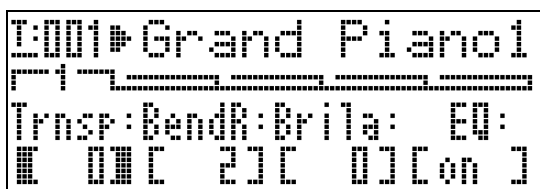

- To turn off the Digital Piano, press the **41 (POWER)** button again.

IMPORTANT!

- Normally, turning power off and then back on again will return the Digital Piano to its initial power on default settings. If you perform the backup operation (page E-40), turning power back on again will restore the backed up settings. Perform a backup (page E-40) or registration operation (page E-34) to save the keyboard setup if you need to restore it later.

Listening to Demo Tunes

1. While holding down the **7 (PART)** button, press the **6 (PLAY/STOP)** button.
 - This starts demo tune play.
 - The Digital Piano has a total of four demo tunes. You can use the **19** buttons to jump the beginning of the previous (**^**) or next (**v**) demo tune. You can use the Tone Group buttons (**20** to **23**) to select a specific demo tune.
 - You can play along on the keyboard with demo tune play. Note, however, that you cannot change the tone assigned to the keyboard. Only the key operations described above are supported.
2. To stop demo tune playback, press the **6 (PLAY/STOP)** button again.

Selecting a Tone

Your Digital Piano comes with 250 tones (which include 10 drum sets) built in. Tones are divided into the eight tone groups shown below.

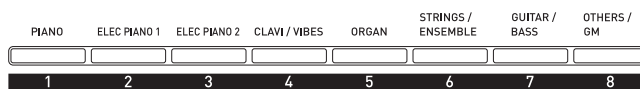

Use the following procedure to select a single tone that is applied across the entire keyboard.

To select a tone

1. Use the “Tone List” (page E-57) to look up the group and the number of the tone you want to select.
2. Check to make sure that the lamp above the **11 (MASTER CONTROL)** button is lit.
 - If it is unlit, press the **11 (MASTER CONTROL)** button to light it.
3. Check to make sure that the both the **28 (LAYER)** and **29 (SPLIT)** button lamps are unlit.
 - If they are lit, press the **28 (LAYER)** and/or **29 (SPLIT)** buttons to turn off both lamps.
4. If the **4 (UPPER 1)** button lamp is unlit, press the **4 (UPPER 1)** button so its lamp is lit.

- Check to make sure that the lamp above the **17 (TONE)** button is lit.

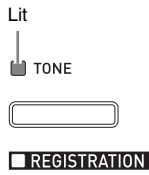

- If it is unlit, press the **17 (TONE)** button to light the upper lamp.

- Use the **20** to **27** (Tone Group) buttons to select the group you want.

- The lamp of the button you press will light.

- Use the **19** (∇ , \wedge) buttons to select the tone you want. Now you can play on the keyboard using the tone you selected.

Example: To select the “Jazz Organ 2” tone in the “ORGAN” group

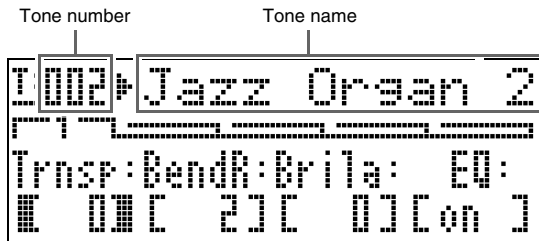

NOTE

- Pressing ∇ and \wedge at the same time selects tone 001 in the currently selected group.
- Holding down ∇ or \wedge will scroll through tones at high speed.
- Holding down the **18 (FUNCTION)** button as you press ∇ or \wedge will jump 10 tones.

Layering and Splitting Tones

You can configure the keyboard so it plays two different tones at the same time (Layer) or to play different tones in the left and right ranges (Split). You can even use Layer and Split in combination with each other.

The following describes the various possible Layer and Split combinations.

- One tone across the entire keyboard (page E-11)**
Use zone UPPER 1.



- Two layered tones across the entire keyboard (page E-13)**
Use zones UPPER 1 and UPPER 2 at the same time.

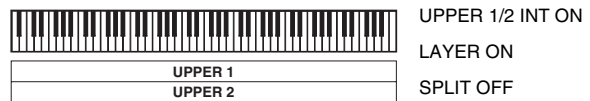

- Two tones, one for the left range and one for the right range of the keyboard (page E-14)**
Use zones UPPER 1 and LOWER 1 at the same time.



- Four tones, two layered for the left range and two layered for the right range of the keyboard (page E-15)**
Use zones UPPER 1, UPPER 2, LOWER 1, and LOWER 2 at the same time.



- Three tones, one for one range and two layered for the other range of the keyboard (page E-16)**
Use all four zones at the same time, but with one zone's sound turned off by configuring one of the zones with INT OFF to disconnect the internal sound source. The example below shows INT OFF configured for LOWER 2.



IMPORTANT!

- You can select a tone for each zone in both the MASTER CONTROL and CARD PLAYER modes. Note however that some procedures and operations (lamp lighting status) when a tone is selected for each zone in the CARD PLAYER mode are different from those in the case of the MASTER CONTROL mode.

Here, explanations are based on selecting a tone for each zone in the MASTER CONTROL mode. For information about selecting tones in the CARD PLAYER mode, see “To select a tone for each zone in the CARD PLAYER mode” (page E-44).

NOTE

- When using Layer and/or Split to play more than one tone at the same time, you can adjust the volume balance of each zone, perform octave shift for each zone, and configure detailed settings for the effects applied to zones. For details about parameters that can be configured and setting procedures, see “Editing Zone Parameters” (page E-28).

Layering Two Tones

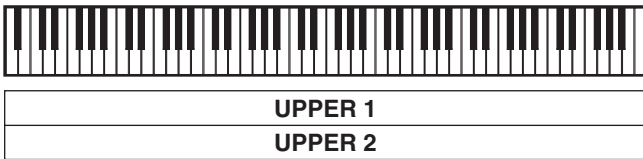

- Use the “Tone List” (page E-57) to look up the group(s) and numbers of the two tones (UPPER 1 zone tone and UPPER 2 zone tone) you want to use.
- Check to make sure that the both the **28 (LAYER)** and **29 (SPLIT)** button lamps are unlit.
 - If one or both lamps are lit, press the **28 (LAYER)** and **29 (SPLIT)** buttons to turn them off.

- Press the **4 (UPPER 1)** button so its lamp is lit.
 - This indicates you can select the UPPER 1 zone tone.

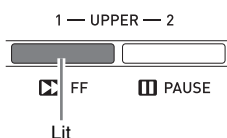

- Select the UPPER 1 zone tone.
 - For details about selecting tones, see “To select a tone” (page E-11).

- Press the **28 (LAYER)** button so its lamp is lit.

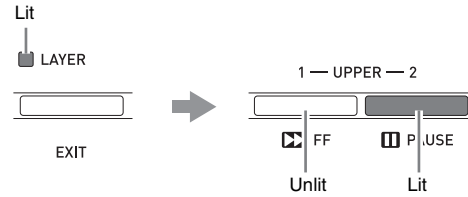

- At this time the **4 (UPPER 1)** button lamp will go out and the **5 (UPPER 2)** button lamp will light in its place. This indicates you can select the UPPER 2 zone tone.

- Select the UPPER 2 zone tone.

- Play something on the keyboard to check how the tones sound layered together.

- At any time you can press the **4 (UPPER 1)** button to change the UPPER 1 zone tone or the **5 (UPPER 2)** button to change the UPPER 2 zone tone.

- To cancel tone layering, press the **28 (LAYER)** button again so its lamp goes out.

Splitting the Keyboard between Two Tones

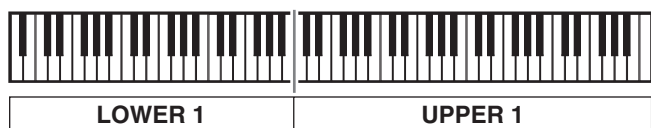

1. Use the “Tone List” (page E-57) to look up the group(s) and numbers of the two tones (UPPER 1 zone tone and LOWER 1 zone tone) you want to use.
2. Check to make sure that the both the **23** (LAYER) and **29** (SPLIT) button lamps are unlit.
 - If one or both lamps are lit, press the **23** (LAYER) and **29** (SPLIT) buttons to turn them off.
3. Press the **4** (UPPER 1) button so its lamp is lit.
 - This indicates you can select the UPPER 1 zone tone.

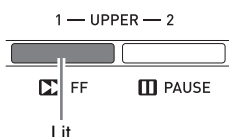

4. Select the UPPER 1 zone tone.
 - For details about selecting tones, see “To select a tone” (page E-11).
5. Press the **29** (SPLIT) button so its lamp is lit.

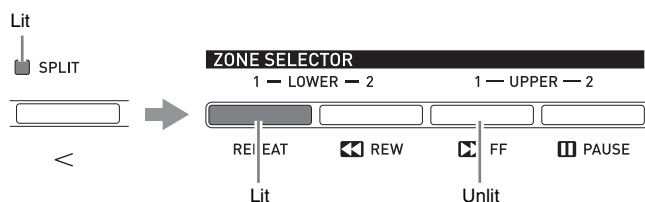

- At this time the **4** (UPPER 1) button lamp will go out and the **2** (LOWER 1) button lamp will light in its place. This indicates you can select the LOWER 1 zone tone.
6. Select the LOWER 1 zone tone.
 7. Play something on the left and right sides of the keyboard to confirm that the tones are assigned properly.
 - At any time you can press the **4** (UPPER 1) button to change the UPPER 1 zone tone or the **2** (LOWER 1) button to change the LOWER 1 zone tone.

8. To cancel the keyboard split, press the **29** (SPLIT) button again so its lamp goes out.

NOTE

- You also can specify the keyboard split point, which the location where the keyboard splits between the left range and right range. In initial default split point is at key F#3.

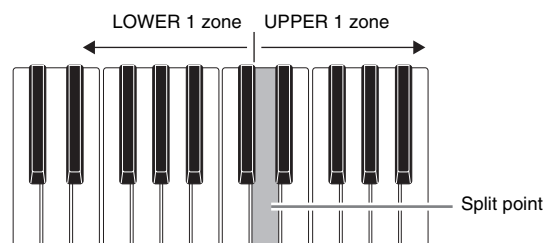

For details, see “To specify the keyboard split point” (page E-14).

To specify the keyboard split point

1. Hold down the **29** (SPLIT) button until the screen shown below appears.

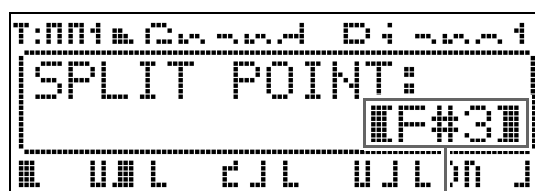

Current split point key name

2. Press the keyboard key that you want to be the leftmost key in the right side (UPPER 1 zone) range.
 - The name of the key you press will appear on the display as the new split point key name.
 - You also can use the **19** (V, ^) buttons to change the split point key name.
3. When you are finished, press the **29** (SPLIT) button.

To use layer and split together

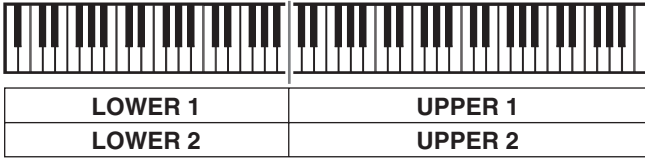

1. Use the “Tone List” (page E-57) to look up the group(s) and numbers of the tones (UPPER 1, UPPER 2, LOWER 1, and LOWER 2 zone tones) you want to use.

2. Check to make sure that the both the 28 (LAYER) and 29 (SPLIT) button lamps are unlit.

- If one or both lamps are lit, press the 28 (LAYER) and 29 (SPLIT) buttons to turn them off.

3. Press the 4 (UPPER 1) button so its lamp is lit.

- This indicates you can select the UPPER 1 zone tone.

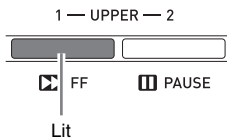

4. Select the UPPER 1 zone tone.

- For details about selecting tones, see “To select a tone” (page E-11).

5. Press the 28 (LAYER) button so its lamp is lit.



- This will cause the 5 (UPPER 2) button lamp to light. This indicates you can select the UPPER 2 zone tone.

6. Select the UPPER 2 zone tone.

7. Press the 28 (LAYER) button so its lamp is unlit.

8. Press the 29 (SPLIT) button so its lamp is lit.

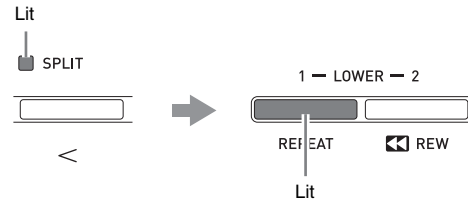

- This will cause the 2 (LOWER 1) button lamp to light. This indicates you can select the LOWER 1 zone tone.

9. Select the LOWER 1 zone tone.

10. Press the 28 (LAYER) button so its lamp is lit.

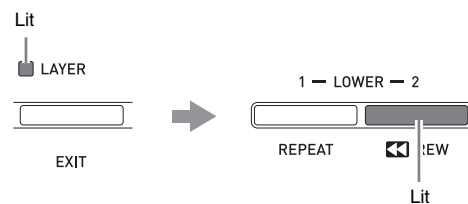

- This will cause the 3 (LOWER 2) button lamp to light. This indicates you can select the LOWER 2 zone tone.

11. Select the LOWER 2 zone tone.

12. Play something on the left and right sides of the keyboard to confirm that the tones are assigned and layered properly.

- You can change any of the zone tones at any time by performing one of the operations shown below.

To change this zone's tone:	Do this:
UPPER 1 zone	Press the 4 (UPPER 1) button and then select a tone.
UPPER 2 zone	Press the 5 (UPPER 2) button and then select a tone.
LOWER 1 zone	Press the 2 (LOWER 1) button and then select a tone.
LOWER 2 zone	Press the 3 (LOWER 2) button and then select a tone.

- To cancel layer and split, press **23 (LAYER)** and **29 (SPLIT)** buttons again so their lamps go out.

NOTE

- When using Layer and Split at the same time, you can switch to only a single tone in either of the keyboard ranges by configuring INT OFF for the zone whose tone you do not want to sound. For example, you could perform the steps below to sound zones UPPER 1, UPPER 2, and LOWER 1, without sounding the LOWER 2 zone.

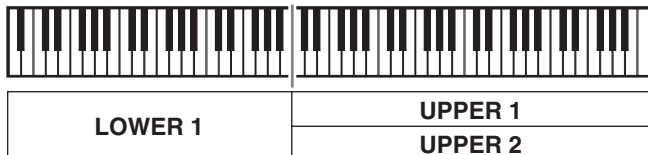

- Press the **3 (LOWER 2)** button so its lamp is lit.
- Press the **6 (INT/EXT)** button twice so the INT side (left side) lamp goes out.

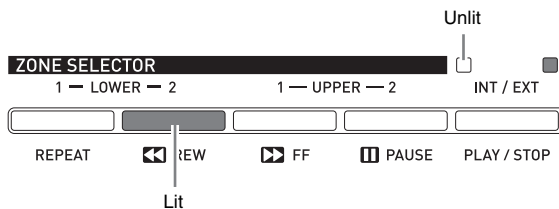

- Pressing the **4 (UPPER 1)**, **5 (UPPER 2)**, **2 (LOWER 1)** or **3 (LOWER 2)** button causes the lamp of the pressed button to light, and the lamps of the other buttons to go out. At this time, the tone name of the zone whose button you press will appear on the display, and you can change the tone, if you want. However, the tones that sound when a keyboard keys are pressed depend on the current Layer and Split on/off settings.
- The **6 (INT/EXT)** button is for specifying what each zone controls (INT = internal sound source, EXT = external MIDI device). The INT (left) side lamp indicates internal sound source control on/off, while the EXT (right) side indicates external MIDI device control on/off. For details about this button, see “Using the Digital Piano as a MIDI Master Keyboard” (page E-26).

Applying Effects to a Tone

MASTER CONTROL CARD PLAYER

Reverb and Chorus

Your Digital Piano provides four types of reverb and four types of chorus. The reverb and chorus functions have their own dedicated keys for easy on/off operation.

- Each press of the **30 (REVERB)** button toggles reverb on and off. The lamp above the button is lit when reverb is on, and unlit when it is off.
- Each press of the **31 (CHORUS)** button toggles chorus on and off. The lamp above the button is lit when chorus is on, and unlit when it is off.



IMPORTANT!

- Under initial default settings of certain tones, chorus is not applied simply by turning chorus on. This is because the initial default value of the chorus send setting is 0. To apply chorus, change the chorus send value of the zone where you want to use it. For details, see “Effect Settings” (page E-32).

NOTE

- The reverb and chorus on/off setting is applied to all zones, but reverb send and chorus send settings can be configured for individual zones. For details, see “Effect Settings” (page E-32).

To change the reverb type

1. Hold down the **30 (REVERB)** button until the screen shown below appears.

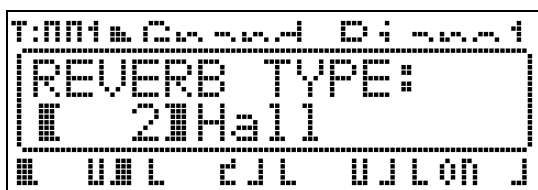

2. Use the **19 (∇, ▲)** buttons to select the reverb type you want.
 - You can select one of the following reverb types:
 - ① Room, ② Hall, ③ Large Hall, ④ Stadium.
3. When you are finished, press the **30 (REVERB)** button.

To change the chorus type

1. Hold down the **31 (CHORUS)** button until the screen shown below appears.

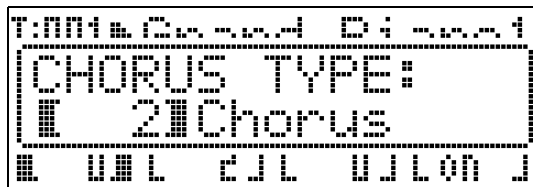

2. Use the **19 (∇, ▲)** buttons to select the chorus type you want.
 - You can select one of the following chorus types:
 - ① Light Chorus, ② Chorus, ③ Deep Chorus, ④ Flanger.
3. When you are finished, press the **31 (CHORUS)** button.

Pitch Bend Wheel

The **34 (PITCH BEND)** wheel lets you change the pitch of notes you are playing by rotating the wheel forward or back. Rotating the wheel away from you raises the pitch, while rotating it towards you lowers it. Releasing the wheel causes the pitch of the notes to return to normal automatically.

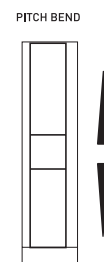

IMPORTANT!

- Do not have the pitch bend wheel rotated as you turn on the Digital Piano.

NOTE

- You also can change the range of the pitch bend wheel. See “Bend Range” (page E-20).

Confirming Common Parameter Settings

MASTER CONTROL

Common parameters include transpose, bend range, equalizer, and other global parameters. Common parameters also include the settings of the function assigned to the **ASSIGNABLE** buttons.

Common Parameters Operations

The common parameter settings appear on the common menu that appears first whenever you turn on the Digital Piano.

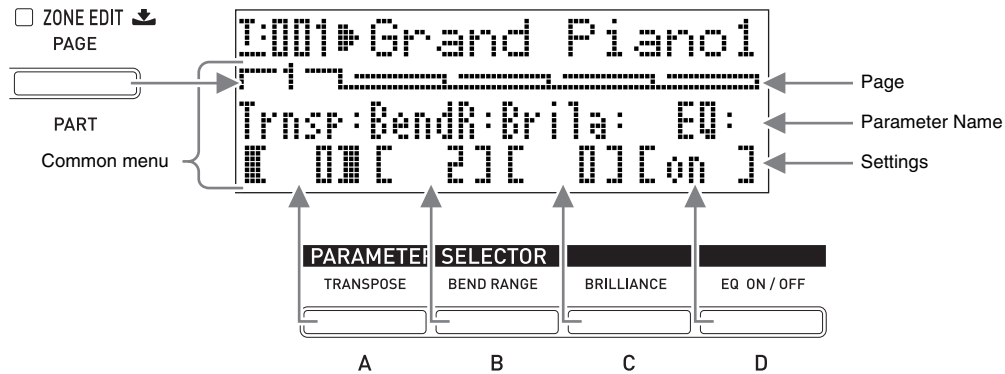

- The common menu has five pages. Press the **7** (**PAGE**) button to scroll through the pages.
- Each common menu page includes up to four parameters, each of which corresponds one of the **PARAMETER SELECTOR** buttons (**12** (**A**) through **15** (**D**)).
- The “COMMON PARAMETER” list in the upper left of the Digital Piano’s control panel shows the parameters assigned to each of the **PARAMETER SELECTOR** buttons.

		COMMON PARAMETER			
	PAGE	A	B	C	D
1	SETTING	TRANSPOSE	BEND RANGE	BRILLIANCE	EQUALIZER ON / OFF
2	EQUALIZER	LOW		LOW MID	
		GAIN	FREQ. (kHz)	GAIN	FREQ. (kHz)
3		HIGH MID		HIGH	
		GAIN	FREQ. (kHz)	GAIN	FREQ. (kHz)
4	ASSIGNABLE 1	TYPE	VALUE 1	VALUE 2	VALUE 3
5	ASSIGNABLE 2	TYPE	VALUE 1	VALUE 2	VALUE 3

To change common parameter settings

1. Check to make sure that the lamp above the **11 (MASTER CONTROL)** button is lit.

- If it is unlit, press the **11 (MASTER CONTROL)** button to light it.

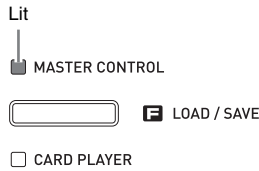

2. Check to make sure that the lamp above the **7 (ZONE EDIT)** button is unlit.

- If the lamp is lit, hold down the **7 (ZONE EDIT)** button until it goes out.

3. Use the **7 (PAGE)** button to display the common menu page that contains the parameter whose setting you want to change.

Example: Common menu page 2

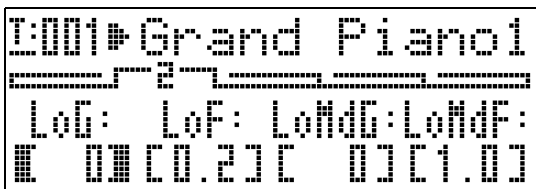

- Each press of the **7 (PAGE)** button advances to the next page.

4. Press the **PARAMETER SELECTOR** button (**12 (A)** through **15 (D)**) to select the parameter whose setting you want to change.

- The brackets around the setting of parameter you select will change from [] to []. This indicates that editing of the setting is enabled.

Example: After the **14 (C)** button is pressed

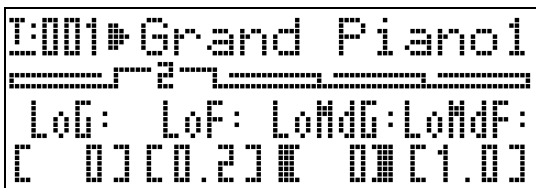

- Holding down one of the **PARAMETER SELECTOR** buttons will display its full name. For example, "LoMdG" will change to "LowMid Gain".

5. Use the **10 (EDIT)** (**∇**, **∧**) buttons to change the setting.

- Pressing **∇** and **∧** at the same time returns the setting to its initial default.
- Holding down **∇** or **∧** will scroll through the settings at high speed.
- For details about the meaning and range of each parameter setting, see "Common Parameter Settings" (page E-20).

6. If you want to change the settings of other parameters, repeat steps 3 through 5 of this procedure.

IMPORTANT!

Turning off the Digital Piano causes all common parameters to return to their initial default settings. If you need to save a common parameter setup, perform one of the operations described below.

- If you want to restore the current setup the next time you turn on the Digital Piano, perform the backup operation. For details, see "Backup" (page E-40).
- If you don't need to restore the current setup the next time you turn on the Digital Piano but want to have it on hand for recall when you need it, save the setup to registration memory. For details, see "Using Registration Memory" (page E-34).

■ 2-A to 3-D Band Gain and Frequency Settings

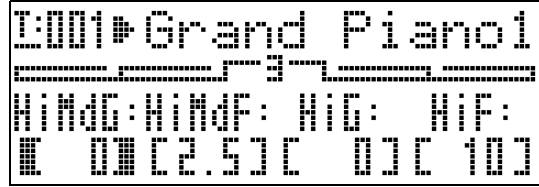
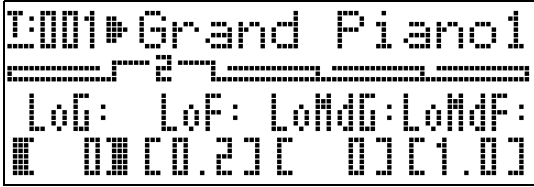

Parameter Name	Location	Description	Settings (* indicates default)
Low Gain (LoG)	2-A	Adjusts the low-range gain.	-12 to 0* to 12
Low Freq. (LoF)	2-B	Specifies the frequency of the low-range adjusted by Low Gain.	0.2*, 0.4, 0.8 kHz
LowMid Gain (LoMdG)	2-C	Adjusts the low mid-range gain.	-12 to 0* to 12
LowMid Freq. (LoMdF)	2-D	Specifies the frequency of the low mid-range adjusted by LowMid Gain.	1.0*, 1.3, 1.6, 2.0, 2.5, 3.2, 4.0, 5.0 kHz
HighMid Gain (HiMdG)	3-A	Adjusts the high mid-range gain.	-12 to 0* to 12
HighMid Freq. (HiMdF)	3-B	Specifies the frequency of the high mid-range adjusted by HighMid Gain.	1.0, 1.3, 1.6, 2.0, 2.5*, 3.2, 4.0, 5.0 kHz
High Gain (HiG)	3-C	Adjusts the high gain.	-12 to 0* to 12
High Freq. (HiF)	3-D	Specifies the frequency of the high-range adjusted by High Gain.	6.0, 8.0, 10* kHz

Assignable Button Settings

These settings specify the functions assigned to the **8** (ASSIGNABLE 1) and **9** (ASSIGNABLE 2) buttons. Functions that can be assigned to each button are shown in the “ASSIGNABLE 1 TYPE” and “ASSIGNABLE 2 TYPE” lists on the control panel to the left of the ASSIGNABLE buttons.

ASSIGNABLE 1 TYPE	ASSIGNABLE 2 TYPE
MODULATION	ROTARY EFFECT
PORTAMENTO	PORTAMENTO
CC# 000 ~ 127	DSP ON / OFF
	CC# 000 ~ 127

NOTE

- Regardless of the settings you configure for the **8** (ASSIGNABLE 1) and **9** (ASSIGNABLE 2) buttons here, you can use the zone editing procedure (page E-28) to enable or disable each individual zone. For details, see “Control Settings” (page E-33).

■ 4-A Assignable Button 1 Type (Asgn1)

Specifies the function assigned to the **③ (ASSIGNABLE 1)** button.

The following describes the functions that can be assigned by each setting.

Setting	Assigned Functions
Modulation (Mod)	This setting assigns modulation to the button.*1 The depth of the modulation is specified using the ⑬ (B) and ⑭ (C) buttons.
Portamento (Por)	This setting assigns portamento to the button. When this function is assigned, portamento is applied while the ③ (ASSIGNABLE 1) button is depressed and not applied while the button is released.*2
Control Change Number 0 to 127 (CC# 000 to 127)	This setting assigns a control change number to the button. The MIDI channel for sending a control change or the value sent when the ③ (ASSIGNABLE 1) button is pressed or released is specified using the ⑬ (B) , ⑭ (C) , and ⑮ (D) buttons.

*1 To apply modulation only to a particular zone, select "001" (CC#1 = Modulation) as the Asgn1 instead of "Mod". Also, specify a control change send MIDI channel that matches the MIDI channel of the zone where you want to apply modulation. For more information, see "Settings when Asgn1/Asgn2 = Control Change Number 0 to 127" (page E-23).

*2 Portamento can be turned on or off for each zone. For details, see "Editing Tones" (page E-31).

■ 5-A Assignable Button 2 Type (Asgn2)

Specifies the function assigned to the **⑨ (ASSIGNABLE 2)** button.

The following describes the functions that can be assigned by each setting.

Settings	Assigned Functions
Rotary (Rot)	This function, which switches rotation speed, can be assigned for the rotary effect used by the DSP (see "DSP Type" on page E-30). The speed is "Fast" when the ⑨ (ASSIGNABLE 2) button is on (lamp lit) and "Slow" when it is off (lamp unlit).
Portamento (Por)	This setting assigns portamento to the button. Portamento is applied when the ⑨ (ASSIGNABLE 2) button is on, and not applied when it is off.*1
DSP Bypass (Dbp)	This setting assigns a function that turns off the DSP of a particular zone. The zone whose DSP is being turned off is specified with the ⑮ (B) button.
Control Change Number 0 to 127 (CC# 000 to 127)	This setting assigns a control change number to the button. The MIDI channel for sending a control change or the value sent when the ⑨ (ASSIGNABLE 2) button is on or off is specified using the ⑬ (B) , ⑭ (C) , and ⑮ (D) buttons.

*1 Portamento can be turned on or off for each zone. For details, see "Editing Tones" (page E-31).

■ 4-B, 4-C Settings when Asgn1 = Modulation (Mod)

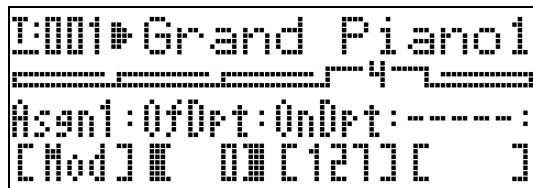

Parameter Name	Location	Description	Settings (* indicates default)
Depth (Button OFF) (OfDep)	4-B	Specifies the modulation depth while the button is not pressed.	0* to 127
Depth (Button ON) (OnDep)	4-C	Specifies the modulation depth while the button is pressed.	0 to 127*

■ 4-B, 4-C, 4-D, 5-B, 5-C, 5-D Settings when Asgn1/Asgn2 = Control Change Number 0 to 127

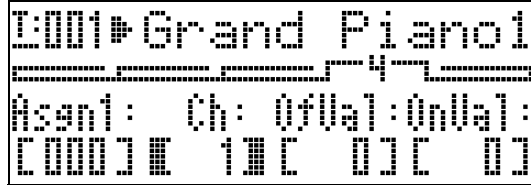

Parameter Name	Location	Description	Settings (* indicates default)
Channel (Ch)	4-B, 5-B	Specifies the MIDI channel*1 for sending control changes.	1* to 16
Value (Button OFF) (OfVal)	4-C, 5-C	Specifies the value sent when the button is released (turned off).	0* to 127
Value (Button ON) (OnVal)	4-D, 5-D	Specifies the value sent when the button is pressed (turned on).	0* to 127

*1 Control change information in principle is sent from the Digital Piano to an external destination over the MIDI channel specified here. However, when a MIDI send channel of one of the Digital Piano's zones matches the channel specified here and that zone is configured as INT ON, control change information is sent for the internal sound source that corresponds to that zone.

■ 5-B Settings when Asgn2 = DSP Bypass (Dbp)



Parameter Name	Location	Description	Settings (* indicates default)
Zone	5-B	This setting can be used to select the zone (Up1: UPPER 1, Up2: UPPER 2, Lo1: LOWER 1, Lo2: LOWER 2) that bypasses the DSP (DSP off) when the  (ASSIGNABLE 2) button is on (lamp lit).	Up1*, Up2, Lo1, Lo2

Using the Assignable Buttons

MASTER CONTROL CARD PLAYER

There are two assignable buttons named **ⓑ** (ASSIGNABLE 1) and **ⓓ** (ASSIGNABLE 2). The **ⓑ** (ASSIGNABLE 1) button is designed so it is on while pressed and off while released. The **ⓓ** (ASSIGNABLE 2) button toggles on (lamp lit) and off (lamp unlit) each time it is pressed.



The main use of the assignable buttons is to perform real-time operations, mainly for effects. You can configure settings for the assignable button with the common menu (page E-18).

NOTE

- For information about how to configure settings, see “To change common parameter settings” (page E-19).
- The “Common Parameter Information” and “Zone Parameter Information” items in the explanations in this section show where you need to go for information about the parameters that come under an assignable function.

Applying Modulation to Notes (ASSIGNABLE 1)

Fixed-depth modulation is applied to notes while the **ⓑ** (ASSIGNABLE 1) button is pressed or released.

Common Parameter Information:

- 4-A Assignable Button 1 Type (Asgn1) (page E-22)
- 4-B, 4-C Settings when Asgn1 = Modulation (Mod) (page E-22)

Applying Portamento to Notes (ASSIGNABLE 1/2)

Applying portamento causes the pitch to slide between two notes played in succession. It is an effect that is used with strings and woodwind instruments. With the **ⓑ** (ASSIGNABLE 1) button, portamento is applied while the button is pressed. With the **ⓓ** (ASSIGNABLE 2) button, portamento is applied while the button is on.

Common Parameter Information:

- 4-A Assignable Button 1 Type (Asgn1) (page E-22)
- 5-A Assignable Button 2 Type (Asgn2) (page E-22)

Zone Parameter Information:

- 4-C Portamento ON/OFF (Porta) (page E-31)
- 4-D Portamento Time (PTime) (page E-31)

Changing the Rotary Effect Speed (ASSIGNABLE 2)

When the rotary effect is being selected by DSP (page E-30), each press of the **ⓓ** (ASSIGNABLE 2) button toggles the rotation speed between fast and slow.

Common Parameter Information:

- 5-A Assignable Button 2 Type (Asgn2) (page E-22)

Zone Parameter Information:

- DSP Settings (page E-30)

By-passing the DSP (ASSIGNABLE 2)

While the **9** (ASSIGNABLE 2) button is on, only the sound of a specified zone is output without passing through the DSP.

Common Parameter Information:

- 5-A Assignable Button 2 Type (Asgn2) (page E-22)
- 5-B Settings when Asgn2 = DSP Bypass (Dbp) (page E-23)



NOTE

- For more information about DSP bypass, see the flowchart under “Master Control Configuration” (page E-4).

Sending Control Changes (ASSIGNABLE 1/2)

Since control change is a MIDI message, the target of a send operation generally is an external MIDI device.*

With the **8** (ASSIGNABLE 1) button, different control change values can be specified for sending at the points the button is pressed and when it is released.

With the **9** (ASSIGNABLE 2) button, different control change values can be specified for sending at the points the button is turned on and when it is turned off.

Common Parameter Information:

- 4-A Assignable Button 1 Type (Asgn1) (page E-22)
- 5-A Assignable Button 2 Type (Asgn2) (page E-22)
- 4-B, 4-C, 4-D, 5-B, 5-C, 5-D Settings when Asgn1/Asgn2 = Control Change Number 0 to 127 (page E-23)

- * You also can configure control change send for the internal sound source that corresponds to a particular zone. See the note under “4-B, 4-C, 4-D, 5-B, 5-C, 5-D Settings when Asgn1/Asgn2 = Control Change Number 0 to 127” (page E-23).

Using the Digital Piano as a MIDI Master Keyboard

A unique MIDI channel can be assigned to each of the Digital Piano's four zones (UPPER 1, UPPER 2, LOWER 1, LOWER 2) to provide simultaneous control of up to four external MIDI devices.

IMPORTANT!

- This section provides only basic information about how to use the Digital Piano as a MIDI master keyboard. For details about the MIDI specifications of this Digital Piano, see the "MIDI Implementation" document at the website located at the URL below.
<http://world.casio.com/>

External MIDI Device Connection

Your Digital Piano is equipped with standard 5-pin DIN connector type MIDI OUT and MIDI IN terminals. It is up to you to purchase optionally available or commercially available MIDI cables when connecting to an external MIDI device.

IMPORTANT!

- The MIDI terminals are disabled while the Digital Piano is connected to a computer via the USB port.

Specifying the Zone Configuration

Press the **LAYER** and **SPLIT** buttons so their lamps are lit in one of the combinations shown below to achieve the zone configuration you want.

LAYER unlit, SPLIT unlit



LAYER lit, SPLIT unlit

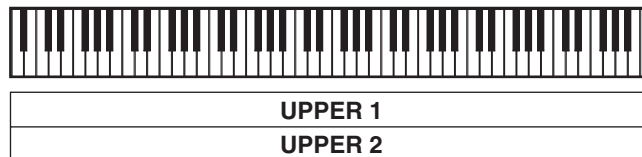

LAYER unlit, SPLIT lit

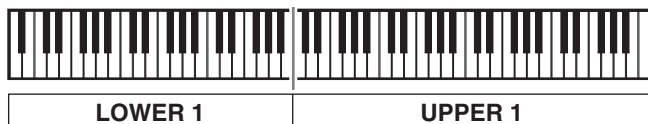

LAYER lit, SPLIT lit

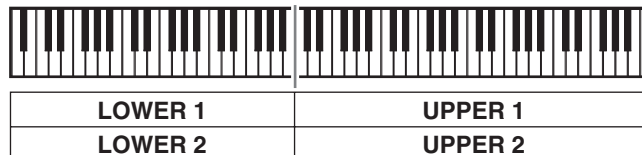

NOTE

- You can change the ranges of the UPPER and LOWER zones using the procedure described under "To specify the keyboard split point" (page E-14).

Specifying What Each Zone Controls

After you use the **28 (LAYER)** and **29 (SPLIT)** buttons to select a zone configuration, you can turn internal sound source control (INT) and external MIDI device control (EXT) on or off as required for each zone. Use the **6 (INT/EXT)** button to specify what a zone controls.

To specify what a zone controls

1. Press the button that corresponds to the zone whose settings you want to change: **4 (UPPER 1)** button, **5 (UPPER 2)** button, **2 (LOWER 1)** button, **3 (LOWER 2)** button.
 - The lamp of the button you press will light.
2. Use the **6 (INT/EXT)** button to specify what you want the zone you selected in step 1 to control.
 - Pressing the **6 (INT/EXT)** button cycles through the available settings, which are indicated by two lamps above the button as illustrated below.

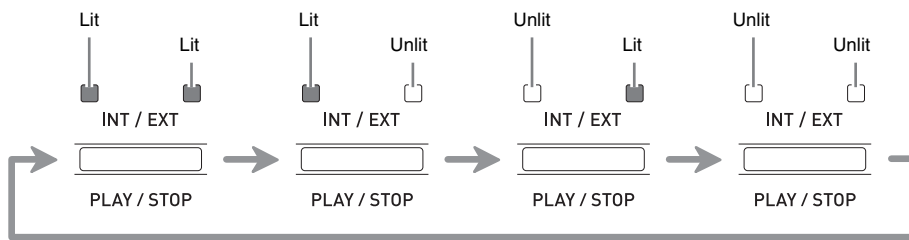

- The INT side lamp indicates the internal sound source, while the EXT side lamp indicates an external MIDI device. Keep pressing the button until the lamp(s) of the device(s) you want the zone to control are lit.
3. If you want to configure other zones, repeat steps 1 and 2 of this procedure as required.

NOTE

- If you want to use the Digital Piano exclusively as an external MIDI device controller, you can turn off the local control setting (page E-39), which severs the actual connection between its keyboard and the internal sound source.

Zone Setups

In addition to the MIDI channel, you can configure external MIDI device control settings and internal sound source settings (tone selection, DSP settings) for each individual zone.

- For the procedure to use to select a tone for each zone, see “Layering and Splitting Tones” (page E-12).
- For information about configuring MIDI channel, mixer, DSP, and other detailed settings for each zone, see “Editing Zone Parameters” (page E-28).

Editing Zone Parameters

Your Digital Piano is a four-zone MIDI master keyboard (“Master Control Configuration”, page E-4). A zone is a unit that controls the internal sound source and/or external MIDI device. Just as you can select a different internal sound source tone for each zone, you also can specify a mixer, DSP and other settings for an internal sound source, and you can specify a MIDI channel and other control settings for an external MIDI device.

Zone Parameter Operations

The parameters whose settings can be configured for each zone are called “zone parameters.” To configure zone parameter settings, enter the MASTER CONTROL mode and then hold down the **7** (ZONE EDIT) button until the zone menu appears on the display.

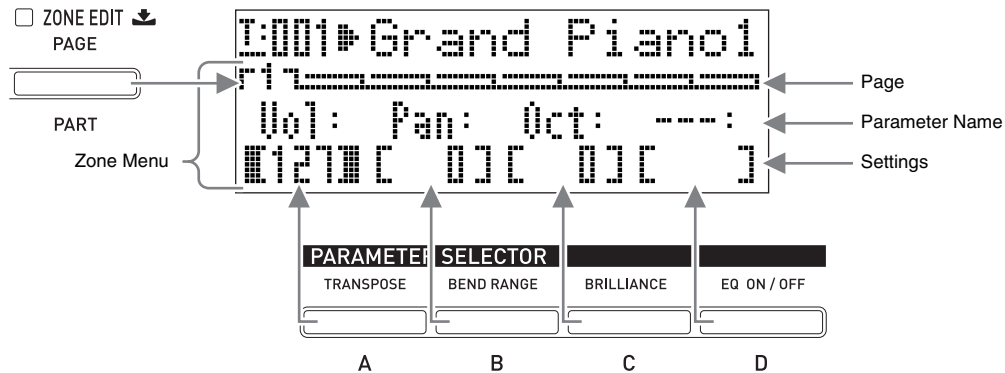

- The zone menu has eight pages. Press the **7** (ZONE EDIT) button to scroll through the pages.
- Each zone menu page includes up to four parameters, each of which corresponds one of the **PARAMETER SELECTOR** buttons (**12** (A) through **15** (D)).
- The format of the DSP settings on page 3 of the zone menu is a bit different from the other pages, as shown below.

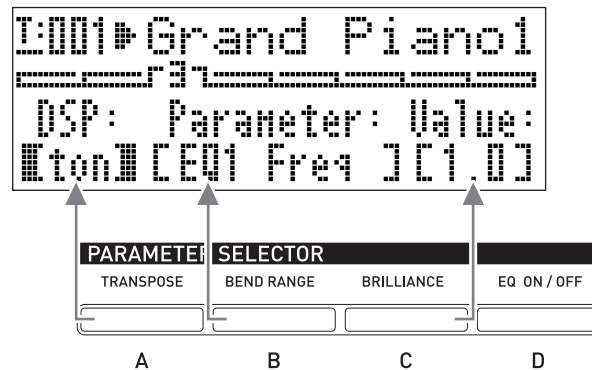

- The “ZONE PARAMETER” list in the upper left of the Digital Piano’s control panel shows the zone parameters assigned to each of the **PARAMETER SELECTOR** buttons.

		ZONE PARAMETER			
PAGE		A	B	C	D
1	MIXER	VOLUME	PAN	OCTAVE SHIFT	
2	MIDI	MIDI CH	MSB BANK SELECT	LSB	PROGRAM CHANGE
3	DSP	TYPE	PARAMETER	VALUE	
4	SYNTH	COARSE TUNE	FINE	ON/OFF PORTAMENTO	TIME
5		ATTACK	RELEASE	FILTER	TOUCH SENSE
6		RATE	DEPTH	VIBRATO	DELAY
7	EFFECT	REVERB SEND	CHORUS SEND	ACO. RESONANCE	DSP ON / OFF
8	CONTROLLER	PEDAL	BENDER	1 ASSIGNABLE	2

To change zone parameter settings

1. Check to make sure that the lamp above the **1** (MASTER CONTROL) button is lit.

- If it is unlit, press the **1** (MASTER CONTROL) button to light it.

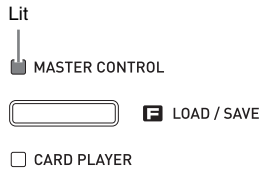

2. Hold down the **7** (ZONE EDIT) button until the zone menu screen shown below appears.

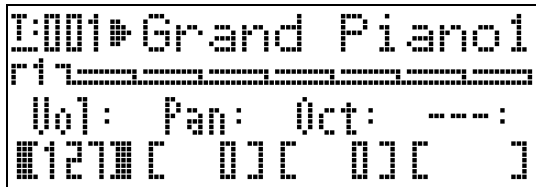

- This will cause the **7** (ZONE EDIT) button lamp to light.

3. Use the **7** (ZONE EDIT) button to display the zone menu page that contains the parameter whose setting you want to change.

Example: Zone menu page 2

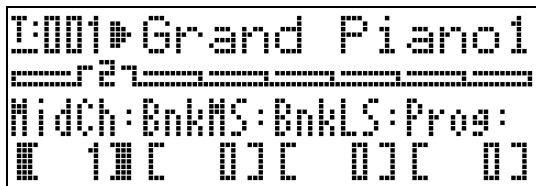

- Each press of the **7** (ZONE EDIT) button advances to the next page.

4. Press the **PARAMETER SELECTOR** button (**12** (A) through **15** (D)) to select the parameter whose setting you want to change.

- The brackets around the setting of parameter you select will change from [] to []. This indicates that editing of the setting is enabled.

Example: After the **14** (C) button is pressed

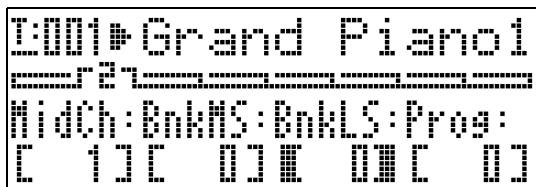

- Holding down one of the **PARAMETER SELECTOR** buttons will display its full name. For example, "MidCh" will change to "MIDI Out Ch".

5. Press the button that corresponds to the zone whose settings you want to change:
 - 4** (UPPER 1) button, **5** (UPPER 2) button, **2** (LOWER 1) button, **3** (LOWER 2) button.
 - The lamp of the button you press will light, which indicates its zone is selected.

6. Use the **10** (EDIT ∇ , \wedge) buttons to change the setting.

- Pressing ∇ and \wedge at the same time returns the setting to its initial default.
- Holding down ∇ or \wedge will scroll through the settings at high speed.
- For details about the meaning and range of each parameter setting, see "Zone Parameter Settings" (page E-30).

7. If you want to change the setting of the same parameter in other zones, perform steps 5 and 6 again.

8. If you want to change the setting of another parameter, perform steps 3 through 7 again as required.

9. After all of the zone parameters are the way you want, hold down the **7** (ZONE EDIT) button until the button lamp goes out.

- This will return the menu along the bottom of the display to the common menu.

IMPORTANT!

Turning off the Digital Piano causes all zone parameters to return to their initial default settings. If you need to save a zone parameter setup, perform one of the operations described below.

- If you want to restore the current setup the next time you turn on the Digital Piano, perform the backup operation. For details, see "Backup" (page E-40).
- If you don't need to restore the current setup the next time you turn on the Digital Piano but want to have it on hand for recall when you need it, save the setup to registration memory. For details, see "Using Registration Memory" (page E-34).

Zone Parameter Settings

This section explains the meaning of each zone parameter, and provides information about their setting ranges and initial default values.

- In this section, each parameter is preceded by a number and a letter, like "1-A". This indicates the common menu page number (1) and the **PARAMETER SELECTOR** button you need to press to select it (A).
- In this section, the name of each zone parameter is followed by **INT** and/or **EXT**.
INT indicates a setting that applies to internal sound source control.
EXT indicates a setting that applies to external MIDI device control.
- The values following the description of a parameter are its setting range. The initial default setting is indicated by an asterisk (*).

Mixer Settings

■ 1-A Volume (Vol)

Adjusts the volume level. 0 is mute, 127 is maximum volume. **INT / EXT**
 0 to 127*

■ 1-B Pan

Adjusts the pan position. 0 specifies a center pan position, a negative value shifts it to the left, and a positive value shifts it to the right. **INT / EXT**
 -64 to 0* to +63

■ 1-C Octave Shift (Oct)

Shifts the pitch upwards or downwards in octave steps. Changing this setting also shifts the note number sent to an external MIDI device. **INT / EXT**
 -2 to 0* to +2

MIDI Settings

■ 2-A MIDI Out Channel (MidCh)

Specifies the MIDI channel used by each zone when sending MIDI data. **EXT**
 1 to 16 (*UPPER 1: 1, UPPER 2: 2, LOWER 1: 3, LOWER 2: 4)

■ 2-B Bank MSB (BnkMS)

Specifies the value of the bank MSB that is appended when sending a program change to an external destination with operation 2-D. **EXT**
 0* to 127

■ 2-C Bank LSB (BnkLS)

Specifies the value of the bank LSB that is appended when sending a program change to an external destination with operation 2-D. **EXT**
 0* to 127

■ 2-D Program Change (Prog)

Specifies the program change number sent to an external destination. Any time this value is changed, the corresponding numbered program change is sent to an external destination (without affecting the internal sound source). **EXT**
 0* to 127

DSP Settings

■ 3-A DSP Type (DSP)

Selects tremolo, rotary, or some other DSP type. The DSP type is indicated by "ton" (which is the initial default for each tone) or a number from 1 to 64. Any time the **10** (EDIT **∨**, **∧**) buttons are used to switch the number, the DSP type name that corresponds to the current number will appear on the display. **INT**
 The parameters displayed in 3-B depend on the DSP type selected here.

■ 3-B DSP Parameter (Parameter)

In accordance with the DSP type selected in 3-A, displays the name of the parameters whose settings can be configured. When there are multiple parameters, you can use the **10** (EDIT **∨**, **∧**) buttons to scroll through them. Perform the operation under 3-C to change the setting of a parameter. **INT**

■ 3-C Parameter Value (Value)

This item is used to change the setting of the parameter displayed in 3-B. INT / EXT

IMPORTANT!

- For details on information about parameter names and the settings and initial defaults for each parameter under each DSP type number and type name, see “DSP Effect List” (page E-60) and “DSP Algorithm List” (page E-61).

Editing Tones**■ 4-A Coarse Tune (CrsTu)**

Changes the pitch in semitone steps. INT / EXT
-12 to 0* to +12 semitones

■ 4-B Fine Tune (FinTu)

Use this item to adjust the pitch in cent steps (1 cent = 1/100 semitone). INT / EXT
-99 to 0* to +99 cents

■ 4-C Portamento ON/OFF (Porta)

Specifies whether or not portamento should be applied to each zone when the assignable button to which portamento is assigned is pressed. INT / EXT
OFF*, ON

■ 4-D Portamento Time (PTime)

Specifies the pitch change time when portamento is turned on in 4-C. A smaller number specifies a shorter time, while a larger number specifies a longer time. Portamento is not applied when this setting is 0. INT / EXT
0* to 127

■ 5-A Attack Time (Atack)

Attack time is the time it takes for the sound to reach full volume when a note is played. This item makes relative adjustments to the default attack time (0) of each tone. A larger positive value lengthens the attack time, which produces a slower attack. A larger negative absolute value shortens the attack time, which produces a faster attack. INT / EXT
-64 to 0* to +63

■ 5-B Release Time (Relas)

Release time is the time it takes for the sound to fade when a note ends. INT / EXT
Adjustment is relative from the initial default setting (0) of each tone. A larger negative absolute value shortens the release time, while a larger positive value lengthens the release time.
-64 to 0* to +63

■ 5-C Filter Cutoff (Filter)

This item is for adjusting how the cut-off filter application is applied to a tone. INT / EXT
The cut-off filter is a tone adjustment filter that eliminates (cuts off) all components over a given frequency from within a tone's overtone components. Adjustment is relative from the initial default setting (0) of each tone.
A larger negative absolute value produces a softer sound, while a larger positive absolute value produces a harder, brighter sound.
-64 to 0* to +63

■ 5-D Touch Sense (Sense)

This item is for adjusting how much the sound volume and timbre changes, and how it changes in accordance with keyboard pressure. INT
Setting a larger absolute value causes relatively large change in sound volume and timbre in response to changes in key pressure. If this setting is 0, sound volume and timbre remain constant regardless of key pressure.
If the setting is positive, a larger value results in harder notes when stronger pressure is applied, and softer notes when lighter pressure is applied. If the setting is negative, a larger value results in softer notes when stronger pressure is applied, and harder notes when lighter pressure is applied. The change in sound volume and timbre depends on the tone.
-64 to 0 to +63*

■ 6-A Vibrato Rate (VbRat)

This item is for adjusting the speed of vibrato applied to notes. A larger negative absolute value decreases the speed, while a larger positive value increases the speed. INT / EXT
-64 to 0* to +63

■ 6-B Vibrato Depth (VbDpt)







This item is for adjusting the depth (strength) of vibrato applied to notes. A larger negative absolute value makes vibrato shallower, while a larger positive value makes it deeper. INT / EXT
 -64 to 0* to +63

■ 6-C Vibrato Delay (VbDly)

This item is for adjusting the time until vibrato starts to be applied to a note. A larger negative absolute value makes the time it takes before vibrato is applied after a note is played shorter, while a larger positive value makes it longer. INT / EXT
 -64 to 0* to +63

■ 6-D Vibrato Waveform (WvFrm)

This item is for selecting the waveform when applying vibrato to notes. You can select from among the following waveforms. INT

Original (Org*)	—	Saw Down (SDw)	
Sine (Sin)		Pulse 1:3 (P13)	
Triangle (Tri)		Pulse 2:2 (P22)	
Saw Up (SUp)		Pulse 3:1 (P31)	

* "Org" is the initial default setting for all tones. The actual default waveform type depends on the tone.

Effect Settings

For details on the meanings of the settings in this section, see the flowchart under "Master Control Configuration" (page E-4).

■ 7-A Reverb Send (RvbSd)

Specifies how much of the signal from the sound source is sent to reverb. INT / EXT
 0 to 127 (*default setting depends on the tone)

■ 7-B Chorus Send (ChoSd)

Specifies how much of the signal from the sound source is sent to chorus. INT / EXT
 0 to 127 (*default setting depends on the tone)

■ 7-C Acoustic Resonance Send (AReso)

Specifies how much of the signal from the sound source is sent to acoustic resonance. INT
 0 to 127 (*default setting depends on the tone)

■ 7-D DSP ON/OFF (DSP)

Switches DSP for each zone on or off. INT
 Selecting OFF disables DSP for that particular zone.
OFF, ON*

The DSP of this Digital Piano can be used simultaneously for up to two parts. Each part ("Sound Source Configuration", page E-5) has a DSP priority, which determines which of the two parts that have DSP turned on should have the DSP effect applied. The following shows the priorities assigned to each part.

Priority	Part Number	Part Name
1	Part 1	Upper1
2	Part 3	Lower1
3	Part 2	Upper2
4	Part 4	Lower2
5	Part 17 to 48	Song01 to Song16, Ext01 to Ext16

To apply a DSP to one or two lower priority parts (Lower2, for example), turn off DSP ON/OFF for the higher priority parts (Upper1, Lower1, Upper2).

Control Settings

If you are using multiple zones for keyboard play and you want to disable pedal and other controller operations for a particular zone, turn off the settings described in this section for that zone.

■ 8-A Pedal

Enables and disables pedal operations. **INT / EXT**
OFF, ON*

■ 8-B Bender (Bend)

Enables and disables the **34** (PITCH BEND) wheel operations. **INT / EXT**
OFF, ON*

■ 8-C Assignable 1 (Asgn1)

Enables and disables the **8** (ASSIGNABLE 1) button operations. **INT / EXT**
OFF, ON*

■ 8-D Assignable 2 (Asgn2)

Enables and disables the **9** (ASSIGNABLE 2) button operations. **INT / EXT**
OFF, ON*

Using Registration Memory

MASTER CONTROL CARD PLAYER

Normally, before playing something you need to set up the Digital Piano by configuring a number of different settings, including layer and split on/off, a tone selection for each zone, equalizer settings, and DSP settings. You can save up to 64 Digital Piano setups (which include control panel and internal settings) to registration memory for later recall when you need them. Each setup is saved as “registration data.”

Registration Data

The following are the settings that are stored as registration data when you save a Digital Piano setup.

- Layer ON/OFF
- Split ON/OFF
- Split point
- Reverb ON/OFF
- Reverb type
- Chorus ON/OFF
- Chorus type
- Each zone tone number
- Each zone INT/EXT ON/OFF
- All common parameters (page E-18)
- All zone parameters (page E-28)
- Following function menu items (page E-38)
 - Touch Response
 - Pedal Assign
 - Temperament type
 - Temperament key note
 - Stretch Tuning
 - Acoustic Resonance ON/OFF
 - Half Pedal Effect

NOTE

- The Digital Piano’s current mode (MASTER CONTROL, CARD PLAYER, ZONE EDIT) is not included in registration data. This means that the Digital Piano’s mode does not change when you recall registration data.
- The following function menu settings are not included in registration data. You can, however, perform the backup operation (page E-40) to retain these settings when the Digital Piano is turned off.
 - Tuning
 - EQ Hold
 - Display Contrast
 - Song MIDI Out
 - Song Volume
 - Song Pre-count
 - Song Repeat
- The backup operation (page E-40) saves all of the above function menu settings, as well as all of the settings that are included in registration data.

Registration Memory Operations

During registration data save and recall operations, the location of the data in registration memory is specified using a bank number and an area number. Registration memory has eight banks, each of which is divided into eight areas.

To save a setup as registration data

1. Configure the Digital Piano with the settings you want to save.
2. Press the **17** (REGISTRATION) button so the lamp below it is lit. This is the REGISTRATION mode.

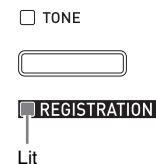

3. Use the **19** (V, ^) buttons to scroll through the banks (1 to 8) until the bank where you want to save the registration data is displayed.

4. While holding down the **32 (STORE)** button, press one of the number buttons (**20 (1)** through **27 (8)**) to specify the number of the area (1 to 8) where you want to save the registration data.

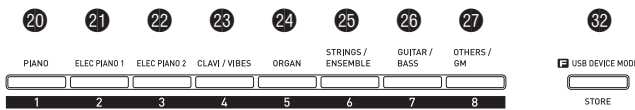

- Pressing a number button immediately executes the registration data save operation.
- The following shows how the display would appear if you select Bank 1, Area 3.

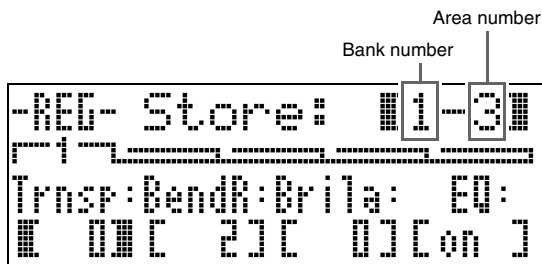

To recall a setup saved as registration data

- Press the **17 (REGISTRATION)** button so the lamp below it is lit. This is the REGISTRATION mode.
- Use the **19 (V, ^)** buttons to scroll through the banks (1 to 8) until the one where the registration data you want to recall is displayed.
- Press one of the number buttons (**20 (1)** through **27 (8)**) to specify the number of the area (1 to 8) where the registration data you want to recall is located.
 - Pressing a number button immediately recalls and applies the setup in accordance with the registration data being recalled.
 - The following shows how the display would appear if you select Bank 3, Area 7.

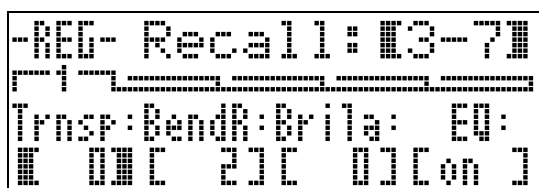

To rename a registration memory bank

- While holding down the **18 (FUNCTION)** button, press the **17 (REGISTRATION)** button.
 - This displays a screen for editing the name.
 - Use the **19 (V, ^)** buttons to scroll through the banks (1 to 8) until the one you want to rename is displayed.
 - The initial default name of all the banks is "REGIBANKNAME".
 - Use the **29 (<)** and **30 (>)** buttons to move the cursor left and right, and the **19 (V, ^)** buttons to scroll through characters at the current cursor position. The following shows the characters that can be used in a name.
- | | | | | | | | | | |
|---|---|---|---|---|---|----|---|---|---|
| 0 | 1 | 2 | 3 | 4 | 5 | 6 | 7 | 8 | 9 |
| A | B | C | D | E | F | G | H | I | J |
| K | L | M | N | O | P | Q | R | S | T |
| U | V | W | X | Y | Z | \$ | & | _ | ' |
| (|) | - | ^ | { | } | @ | ~ | ` | |
- Edit the name.
 - You can specify up to 12 characters for a bank name.
 - After the name is the way you want, press the **31 (ENTER)** button.
 - In response to the confirmation message ("Sure?") that appears, press the **19 (YES)** button to apply the change or the **19 (NO)** button to return to the screen in step 3 of this procedure without changing anything.

NOTE

- To display a bank name, hold down the **17 (REGISTRATION)** button on the registration mode screen.

Saving Registration Memory Bank Data to a File

Registration data can be stored to a file in the Digital Piano's internal memory area or on an SD card. You can store the registration data in a single registration memory bank (eight areas) or the data in all of the registration memory banks (64 areas) to a file.

NOTE

- When you save registration memory bank data to a file, a file name is assigned automatically in accordance with the following rules.
 - If you save the data in a single bank, the file name will be in the format: <first 6 characters of bank name><2-digit number specified by you>.CB6.
 - If you save the data in all the banks, the file name will be in the format: <REGIST><2-digit number specified by you>.CR6.
- Before saving registration memory bank data to an SD card, be sure to first read the important information contained in the following sections of this user's guide.
 - "Card and Card Slot Precautions" (page E-46)
 - "To load and remove a memory card" (page E-46)
 - "To format a memory card" (page E-46)

To save registration memory bank data to a file

1. Depending on where you want to save the data file, perform one of the steps shown below.

If you are saving the file here:	Perform this operation:
Internal area	Remove the SD card from the Digital Piano's card slot.
SD card	Insert the SD card into the Digital Piano's card slot.

2. While holding down the **F18 (FUNCTION)** button, press the **F11 (LOAD/SAVE)** button.
 - This enters the LOAD/SAVE mode.

3. Depending on the type of operation you want to perform, use the **F29 (<)** and **F30 (>)** buttons to display one of the screens shown below.

To save the data in a single bank

```
--SAVE-- ResistBnk
to CARD:
REGIB01.CB6
>ENT
```

To save the data in all banks

```
--SAVE-- ResistAll
to CARD:
REGIST01.CR6
>ENT
```

4. Use the **F19 (v, ^)** buttons to specify the two-digit number you want to append to the name of the file.
5. Press the **F31 (ENTER)** button.
 - This saves the file.
 - The message "Replace?" will appear if a file with the same name already exists. If you want to replace the existing file with the one you are saving, press **F19 (YES)**. Press **F19 (NO)** to return to the screen in step 4 of this procedure without saving.
6. To exit the LOAD/SAVE mode, press the **F23 (EXIT)** button.

NOTE

- A registration memory bank data file saved to an SD card will be placed in the MUSICDAT folder. The MUSICDAT folder is created automatically when you format the memory card on the Digital Piano (page E-46). Note that load, delete, and rename operations cannot be performed on files that are not inside the MUSICDAT folder, or on files in folders that are inside the MUSICDAT folder. Keep this restriction in mind whenever handling SD card files with your computer.

To recall registration memory bank data from a file

1. Depending on where the file is located, perform one of the steps shown below.

If the file is located here:	Perform this operation:
Internal area	Remove the SD card from the Digital Piano's card slot.
SD card	Insert the SD card into the Digital Piano's card slot.

2. Press the **17 (REGISTRATION)** button so the lamp below it is lit. This is the REGISTRATION mode.
3. If you are recalling a file that contains data for a single bank, use the **19 (∨, ∧)** buttons to scroll through the bank numbers (1 through 8) until the one to which you want to recall the data is displayed.
 - If you are recalling a file that contains data for all banks, you can skip this step.
4. While holding down the **18 (FUNCTION)** button, press the **11 (LOAD/SAVE)** button.
 - This enters the LOAD/SAVE mode.
5. Depending on the type of operation you want to perform, use the **29 (<)** and **30 (>)** buttons to display one of the screens shown below.

To recall a file that contains data for a single bank

```
-LOAD- ResistBnk
from CARD:
■■■■REGIBA01.CB6
>ENT
```

To recall a file that contains data for all banks

```
-LOAD- ResistAll
from CARD:
■■■■REGIST01.CR6
>ENT
```

6. Use the **19 (∨, ∧)** buttons to display the file that contains the data you want to recall, and then press the **31 (ENTER)** button.
 - This will cause the message "Replace?" to appear.
 - To cancel the recall operation and exit the LOAD/SAVE mode, press the **28 (EXIT)** button.

7. To replace the registration data currently in the bank(s) you selected with the registration data in the file, press the **19 (YES)** button. To return to the screen in step 6 of this procedure without recalling anything, press the **19 (NO)** button.

- Pressing the **19 (YES)** button recalls the data from the file into the bank(s) and exits the LOAD/SAVE mode.

The function menu contains global settings (overall tuning and touch adjustment, local control ON/OFF, etc.) that need to be changed by you relatively infrequently. It also includes some SD card operations (format, etc.)

Function Menu Operations

This section explains operations involving function menu settings. For details about specific function menu items, see "Function Menu Settings" (page E-39).

To change the setting of a function menu item

1. Press the **F** (FUNCTION) button.

- The button's lamp will light, and the display will change as shown below.

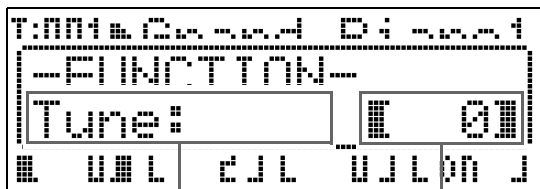

Item name " [] " indicates the setting. ">ENT" indicates a setting group.

2. You can use a number button (**1**) through (**8**) to select another item to change its setting.

- Each number button corresponds to the numbers of the items under "Function Menu Settings" (page E-39).
- You also can scroll sequentially through settings with the **←** and **→** buttons.
- ">ENT" to the right of an item indicates a setting group. In this case, press the **ENTER** button to enter the setting group. Next, use the **←** and **→** buttons to scroll through the items in the group.

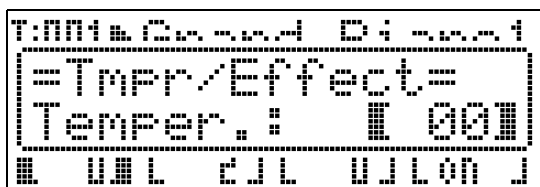
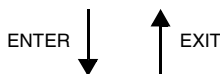
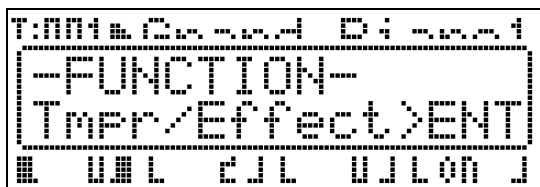

- To exit a setting group, press the **EXIT** button.

3. Use the **↓**, **↑** buttons to change the currently displayed setting.

- Holding down the **F** (FUNCTION) button as you press **↓** or **↑** will change the setting by a factor of 10.

4. To exit the function menu, press the **EXIT** button or the **F** (FUNCTION) button.

IMPORTANT!

- Turning off the Digital Piano causes all function menu settings to return to their initial defaults. If you need to save a function menu setup, perform the backup operation. For details, see "Backup" (page E-40).
- Some function menu settings also can be saved to registration memory. For details, see "Using Registration Memory" (page E-34).

Function Menu Settings

This section explains the meaning of each function menu parameter, and provides information about their setting ranges and initial default values.

- For each item, the initial default setting is indicated by an asterisk (*).

1 Tuning (Tune)

Use this item to adjust the pitch in cent steps (1 cent = 1/100 semitone).

-99 to 0* to +99 cents

2 EQ Hold

Select OFF* to overwrite existing equalizer settings when recalling registration data (page E-34). Select ON to retain existing equalizer settings.

3 Touch Response (Touch)

Select one of the settings below to specify the relationship between key pressure and note volume.

OFF: Constant note volume regardless of keyboard pressure

- 1 : Strong sound even with light pressure
- 2* : Normal
- 3 : Normal sound even with strong pressure

4 Pedal Assign (PedAssign)

Specifies whether the pedal unit connected to the **SOFT/SOSTENUTO PEDAL** jack is a soft pedal (SFT*) or a sostenuto pedal (SOS).

5 Local Control (LocalCtl.)

Select OFF to disconnect the Digital Piano's keyboard from the internal sound source.

OFF, ON*

6 Temperament/Effect (Tmpr/Effect)

Temperament (Temper.)

Use this setting to select one of the temperaments (tunings) shown below for the internal sound source. Pressing a keyboard key while this item is displayed will set that key's note name (C* to B) as the temperament key note.

00* : Equal	09 : Hijaz
01 : Pure Major	10 : Saba
02 : Pure Minor	11 : Dashti
03 : Pythagorean	12 : Chahargah
04 : Kirnberger 3	13 : Segah
05 : Werckmeister	14 : Gurjari Todi
06 : Mean-Tone	15 : Chandrakauns
07 : Rast	16 : Charukeshi
08 : Bayati	

NOTE

- Equal temperament is always used for MIDI file playback in the CARD PLAYER mode.

Stretch Tuning (Stretch)

Stretch tuning is a standard piano tuning method that tunes high notes slightly higher and low notes slightly lower. Select ON* for this item to enable stretch tuning or OFF for plain tuning.

Acoustic Resonance (AcoReson.)

Acoustic resonance occurs when the damper pedal is depressed on a grand piano. Select ON* for this item to enable acoustic resonance or OFF to disable it.

Half Pedal Effect (HalfPedal)

Use this item to adjust how much a half-pedal operation (pressing the pedal part way) when using the damper pedal of the optional pedal unit (SP-32). A setting of 00 disables the half pedal effect. Setting 42 applies a full-press effect, even when the pedal is pressed part way.

00 to 24* to 42

7 Playback/Card (Play/CARD)**Song MIDI Out (MIDI Out)**

Select ON* for this item to send MIDI data to an external destination when a Format0 or Format1 SMF file is played back on the Digital Piano. Select OFF to disable send. MIDI data is never sent during playback of a CM2 format file, regardless of what is selected for this setting.

Song Volume (SongVol.)

Use this item to adjust the volume level for playback of MIDI files on the Digital Piano. This item can be used to balance the volume level of MIDI file playback with keyboard play volume. A setting of 00 mutes MIDI file playback.

00 to 42*

Song Pre-count (PreCount)

Select ON for this item to sound a pre-count at the beginning of a song when starting playback of a MIDI file on the Digital Piano. Select OFF* to disable the pre-count.

Song Repeat (SngRepeat)

Select ON for this item to repeat a single song when playing back a MIDI file on the Digital Piano. Select OFF* to disable song repeat.

Card Folder Setting (CardFolder)

See "Creating a New Card Music Folder" (page E-44).

Card Format (CardFORMAT)

See "To format a memory card" (page E-46).

File Delete (FileDELETE)

See "To delete a file" (page E-47).

File Rename (FileRENAME)

See "To rename a file on a memory card" (page E-47).

8 Other (General)**Panel Lock (PanelLock)**

Turning on panel lock locks all of the Digital Piano's buttons (except for the power button and unlock button operations*). Turn on panel lock when you want to protect against unintentional button operations. Turning off the Digital Piano automatically unlocks panel lock.

* To unlock the panel, perform the same operation you perform to turn on panel lock.

Display Contrast (Contrast)

Use this item to adjust display contrast.

00 to 08* to 16

Backup (BackUp)

Changing this item from OFF* to ON, creates a backup data file that contains information about all of the Digital Piano's current settings. If this item is left ON, the Digital Piano's setup is configured in accordance with the contents of the currently saved backup data file. For details about the backup data file contents, see the note at the end of "Registration Data" (page E-34).

**NOTE**

- Changing the backup setting from ON to OFF deletes the current backup data file. Turning the Digital Piano off and then back on again while the backup setting is OFF will cause all settings to return to their initial power on defaults. Registration memory data and internal memory area data is not affected.
- To update the contents of the backup data file with your current Digital Piano setup, change the backup setting from ON to OFF and then back to ON again.

Playing Back a MIDI File

CARD PLAYER

You can use the Digital Piano to directly playback a MIDI file stored on an SD card. You also can copy MIDI files to the Digital Piano's built-in memory (internal memory area) and play it back from there.

IMPORTANT!

- Your Digital Piano supports playback of Format0 and Format1 SMF files and CM2 (CASIO proprietary) format file. Playback of up to 17 tracks of a Format1 SMF file is supported.
- Playback of audio files (WAV, MP3, etc.) is not supported.

MIDI File Playback Operations

To play back a MIDI file from an SD card

1. Format the SD card on the Digital Piano (page E-46).
 - This will cause folders with the names MUSICDAT, MUSIC_B, MUSIC_C, and MUSIC_D to be automatically created in the SD card's root directory.
2. Use your computer to copy the MIDI files you want to play on the Digital Piano into the folders that were created on the SD card in step 1 of this procedure.
3. Insert the SD card into the Digital Piano's card slot.
4. Press the **11 (CARD PLAYER)** button so the lamp below it is lit. This is the CARD PLAYER mode.
 - The **12 (A)** button will light, and the name of the first MIDI file in the MUSICDAT folder will appear on the Digital Piano's display.



The screenshot shows a monochrome LCD display with the following text:
E:001 Grand Piano1
E:001 RAINSONG.MID

E:001 2:07B

5. You can use the letter buttons (**12 (A)**) through **15 (D)**) to specify an SD card folder.
 - A: MUSICDAT, B: MUSIC_B, C: MUSIC_C, D: MUSIC_D.
6. Use the **19 (V, ^)** buttons to select the MIDI file you want.
7. To start playback, press the **6 (PLAY/STOP)** button.
 - Press the **4 (FF)** button to perform a fast forward operation or the **3 (REW)** button for rewind. Pressing and releasing either button moves one measure, while holding down a button scrolls at high speed.
 - Pressing the **5 (PAUSE)** button pauses playback. Press again to resume song playback.
 - For information about other operations that are supported during playback, see "Supported Operations During MIDI File Playback" (page E-42).
 - Playback will stop when the end of the file is reached (under initial default settings). To stop playback part way through, press the **6 (PLAY/STOP)** button.
8. To exit the CARD PLAYER mode, press the **11 (CARD PLAYER)** button.
 - The lamp above the button will light, and the Digital Piano will return to the MASTER CONTROL mode.

To play back a MIDI file from the Digital Piano's internal memory area

1. Copy the MIDI file you want to play to the Digital Piano's internal memory area.
 - For information about how to copy the file, see "Transferring Data between the Digital Piano and a Computer" (page E-50).
2. If there is an SD card in the Digital Piano's card slot, remove it.

3. Press the **11 (CARD PLAYER)** button so the lamp below it is lit. This is the CARD PLAYER mode.

- This displays the name of the first MIDI file in the internal memory area.

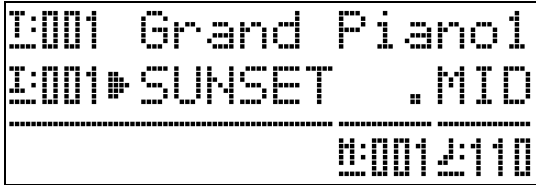

- The remaining steps of this procedure are the same as those starting with step 6 under "To play back a MIDI file from an SD card" (page E-41).

Supported Operations During MIDI File Playback

To change the playback tempo

There are two different methods you can use to change the tempo setting: by pressing **^** (faster) and **v** (slower) buttons or by tapping a beat with a button.

■ To adjust the tempo using the **10 (TEMPO v, ^)** buttons

Each press of a button increases or decreases the beats per minute value by one.

- Holding down either button changes the value at high speed.
- Pressing both of the **10 (TEMPO v, ^)** buttons at the same time will return the song to its default tempo.
- You can specify a tempo value in the range of 20 to 255.

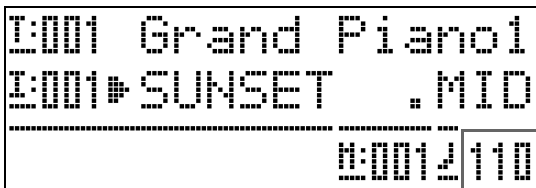

Tempo value

■ To adjust the tempo by tapping a beat

1. While holding down the **18 (FUNCTION)** button, tap the **^ 10 (TEMPO)** button four times in time with the beat you want to specify.

- The tempo setting will change in accordance with the timing of your tapping.
- After you use this method to specify the approximate tempo, you can then use the procedure under "To adjust the tempo using the **10 (TEMPO v, ^)** buttons" to adjust the setting to a more exact value.
- The setting will be canceled if you release the **18 (FUNCTION)** button before tapping the **^ 10 (TEMPO)** button four times.

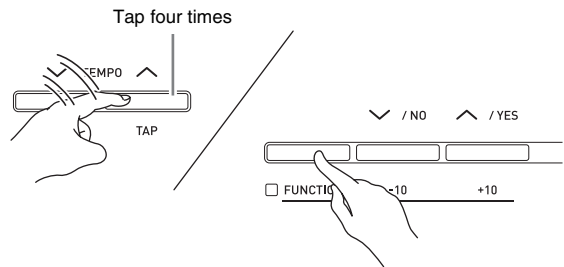

To adjust playback volume in accordance with keyboard play volume

See "Song Volume" (page E-40). For information about how to change the setting, see "To change the setting of a function menu item" (page E-38).

To sound a pre-count at the start of playback

See "Song Pre-count" (page E-40). For information about how to change the setting, see "To change the setting of a function menu item" (page E-38).

To practice with either hand (Part Off)

NOTE

- To perform the procedure below, use a MIDI file that has the left-hand part recorded in Channel 3 and the right-hand part recorded in Channel 4.

1. Enter the **CARD PLAYER** mode and select the MIDI file you want to play.
2. Press the **7 (PART)** button.
 - This will display the part on/off screen (L-[ON] R-[ON]) to appear on the display.
3. Use the **19 (∨, ∧)** buttons to toggle the parts on and off.
 - ∨ toggles the left-hand part and ∧ toggles the right-hand part.
4. Press the **7 (PART)** button to exit the part on/off screen.
5. To start playback, press the **6 (PLAY/STOP)** button.
 - This starts playback of the part you turned on in step 2. You can play the part you turned off on the keyboard along with the playback.

To repeat play a specific section of a song

1. Press the **6 (PLAY/STOP)** button to start song playback.
2. When playback reaches the first beat of the section you want to select for repeat, press the **2 (REPEAT)** button.
 - This will cause the **2 (REPEAT)** button lamp to flash.
3. When playback reaches the last beat of the section, press the **2 (REPEAT)** button again.
 - The **2 (REPEAT)** button lamp will remain lit, which indicates that repeat playback is being performed. After a one-measure (four beats in the cast of a 4/4 time song) rest, the Digital Piano will start playing the section you selected. Playback of the selected section continues, with a one-measure rest before each playback.
 - You can use the **6 (PLAY/STOP)** button to stop and re-start playback of the section.
4. To exit repeat playback, press the **2 (REPEAT)** button again so its lamp goes out.
 - Using the **19 (∨, ∧)** buttons to switch to another song also will exit repeat playback.

To play on the keyboard along with playback

1. In the **MASTER CONTROL** mode, select the tones you want to use for each zone you will play on the keyboard.
 - See “Selecting a Tone” (page E-11) and “Layering and Splitting Tones” (page E-12).
2. Enter the **CARD PLAYER** mode and start MIDI file playback.
 - See “MIDI File Playback Operations” (page E-41).
3. Play on the keyboard along with playback.

NOTE

- The parts used for MIDI file playback (Song01 through Song16) are independent of the parts used for Digital Piano keyboard play (Upper1, Upper2, Lower1, Lower2). For more information, see “Sound Source Configuration” (page E-5). This means that playing on the keyboard does not interfere with proper MIDI file playback.
- You can select the tones for each zone you will play on the keyboard after entering the **CARD PLAYER** mode. For more information, see “To select a tone for each zone in the **CARD PLAYER** mode” (page E-44).

To select a tone for each zone in the CARD PLAYER mode

1. Press the **28 (LAYER)** and **29 (SPLIT)** buttons so their lamps are lit in the combinations shown below and select the tones you want.

To change this zone's tone:	Configure the 28 (LAYER) and 29 (SPLIT) button lamps like this:
UPPER 1 zone	28 (LAYER) : unlit, 29 (SPLIT) : unlit
UPPER 2 zone	28 (LAYER) : lit, 29 (SPLIT) : unlit
LOWER 1 zone	28 (LAYER) : unlit, 29 (SPLIT) : lit
LOWER 2 zone	28 (LAYER) : lit, 29 (SPLIT) : lit

2. Press the **17 (TONE)** button so the lamp above it is lit.
3. Use the **20 to 27 (Tone Group)** buttons to select the group you want.
 - The lamp of the button you press will light.
4. Use the **19 (∨, ∧)** buttons to select the tone you want.
5. Repeat steps 1 through 4 for all of the zones you want to use for keyboard play.

Creating a New Card Music Folder

When you insert an SD card, the Digital Piano searches for MIDI files inside of specific folders on the card. Under initial default settings, the folders that are searched are named "MUSICDAT" (which is assigned to Digital Piano button **12 (A)**), "MUSIC_B" (button **13 (B)**), "MUSIC_C" (button **14 (C)**), and "MUSIC_D" (button **15 (D)**). Pressing a button accesses the contents of the corresponding folder. You can use the procedure below to assign different folders to buttons **13 (B)**, **14 (C)**, and **15 (D)**.

- The procedure below creates a new folder and assigns it to button **13 (B)**, **14 (C)**, or **15 (D)**. Button assignments are stored on the SD card, so if you remove it, the last button assignments you used will be restored the next time you insert the card.
- If you create more than one folder for a button, the last one you create will be assigned to the button.
- Performing the procedure below does not delete or affect the content of the folder currently assigned to a button.

To create a new card music folder

1. Insert the SD card into the Digital Piano's memory card slot.
2. Press the **13 (FUNCTION)** button.
3. Press the **26 (7)** button.
4. Use the **29 (<)** and **30 (>)** buttons to display "CardFolder" and then press the **31 (ENTER)** button.
 - This causes the CARD Folder screen to appear.

```
*CARD Folder*
Folder & Name:
[ B ] MUSIC__B
>ENT
```

5. Use the **19 (∨, ∧)** buttons to scroll through the button names (**B, C, D**) until the one for which you want to create a new folder is displayed within the brackets (**[]**).

6. Enter a name for the folder you want to create.

- Use the **29** (<) and **30** (>) buttons to move the cursor left and right, and the **19** (▼, ▲) buttons to scroll through characters at the current cursor position. The following shows the characters that can be used in a name.

0	1	2	3	4	5	6	7	8	9
A	B	C	D	E	F	G	H	I	J
K	L	M	N	O	P	Q	R	S	T
U	V	W	X	Y	Z	\$	&	_	'
()	-	^	{	}	@	~	`	

- If you know the name of an existing folder on the SD card, you can input the name in the above step. This will assign the existing folder to the applicable button without creating a new folder.

7. After the name is the way you want, press the **31** (ENTER) button.

8. In response to the confirmation message ("Sure?") that appears, press the **19** (YES) button to create the new folder or the **19** (NO) button to return to the screen in step 6 of this procedure without creating anything.

- The message "Please Wait" will remain on the display while the operation is being performed. Do not perform any Digital Piano operation while this message is on the display. "Complete" appears on the display after the operation is complete.

Using a Memory Card

You can save Digital Piano registration data to a commercially available SD memory card, if you want.

- Use a memory card with a capacity of 2GB or less. Use of a card with a capacity that is greater than 2GB or other types of memory cards is not supported.
- In this manual, mentions of a “memory card” refer to an SD memory card.

Types of Data

Data Type	Description (File Name Extension)	Supported Operations	
		Save to Memory Card	Load from Memory Card
Registration (page E-34)	Digital Piano setups (CB6, CR6)	<input type="radio"/>	<input type="radio"/>

Card and Card Slot Precautions

IMPORTANT!

- Be sure to observe the precautions provided in the documentation that comes with the memory card.
- Memory cards have a write-protect switch. Use it when you want to protect the data on the card from accidental deletion.
- Avoid using a memory card under the following conditions. Such conditions can corrupt data stored on the memory card.
 - Areas subjected to high temperature, high humidity, or corrosive gas
 - Areas subjected to strong electrostatic charge and digital noise
- Never touch the contacts of a memory card when loading it or removing it from the Digital Piano.
- Never eject the memory card while data is being written to or loaded from it. Doing so can corrupt the data on the memory card and damage the memory card slot.
- Never insert anything besides a memory card into the card slot. Doing so creates the risk of malfunction.
- Electrostatic charge from your fingers or the memory card to the card slot can cause malfunction of the Digital Piano. If this happens, turn the Digital Piano off and then back on again.
- A memory card can become quite warm after very long use in the memory card slot. This is normal and does not indicate malfunction.

Memory Card Operations

To load and remove a memory card

IMPORTANT!

- A memory card must be positioned correctly when being loaded into the Digital Piano. Trying to force an improperly oriented memory card into the slot can damage the memory card and the slot.

1. With the top of the memory card facing upwards (so you can see it), carefully insert it into the Digital Piano’s memory card slot (33) until stops with a click.

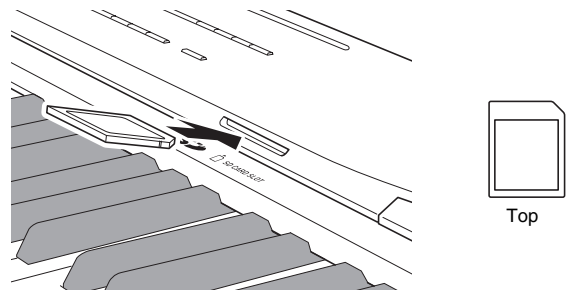

2. To remove the memory card first press it into the slot further.

This will cause the memory card to disengage and eject partially. Pull the memory card the rest of the way out of the slot.

To format a memory card

IMPORTANT!

- Format a memory card before using it for the first time.
- Before formatting a memory card, make sure it does not have any valuable data stored on it.
- The memory card format operation performed by this Digital Piano is a “quick format”. If you want to completely delete all of the data on the memory card, format it on your computer or some other device.

1. Insert the memory card you want to format into the Digital Piano’s memory card slot.

Make sure the write-protect switch of the memory card is not in the write-protect position so writing is enabled.

2. Press the **18 (FUNCTION)** button.
3. Press the **25 (7)** button.

- Use the **29 (<)** and **30 (>)** buttons to display “CardFORMAT” and then press the **31 (ENTER)** button.

This will display a confirmation message (SURE?).

- If you want to cancel the format operation, press the **19 (NO)** or **23 (EXIT)** button.

- Press the **19 (YES)** button.

- The message “Please Wait” will remain on the display while the format operation is being performed. Do not perform any Digital Piano operation while this message is on the display. “Complete” appears on the display after formatting is complete.
- Formatting a memory card will cause folders with the names MUSICDAT, MUSIC__B, MUSIC__C, and MUSIC__D to be automatically created in the card’s root directory.

To delete a file

- Insert the SD card into the Digital Piano’s card slot.
 - This step is not necessary if you are deleting a file for the internal memory area.

- Press the **18 (FUNCTION)** button.

- Press the **26 (7)** button.

- Use the **29 (<)** and **30 (>)** buttons to display “FileDELETE” and then press the **31 (ENTER)** button.

This displays a screen for selecting a file for deletion.

- Use the **19 (∨, ∧)** buttons to select the file you want to delete.

- Press the **31 (ENTER)** button.

This will display a confirmation message (SURE?).

- If you want to cancel the delete operation, press the **19 (NO)** or **23 (EXIT)** button.

- Press the **19 (YES)** button.

- The message “Please Wait” will remain on the display while the delete operation is being performed. Do not perform any Digital Piano operation while this message is on the display. “Complete” appears on the display after deletion is complete.

To rename a file on a memory card

- Insert the SD card into the Digital Piano’s card slot.
 - This step is not necessary if you are renaming a file for the internal memory area.
- Press the **18 (FUNCTION)** button.
- Press the **26 (7)** button.
- Use the **29 (<)** and **30 (>)** buttons to display “FileRENAME” and then press the **31 (ENTER)** button.

This displays a screen for changing the file name.
- Use the **19 (∨, ∧)** buttons to select the file you want to rename.
- Use the **29 (<)** and **30 (>)** buttons to move the flashing cursor to the character you want to change, and then use the **19 (∨, ∧)** buttons to change the character.
 - The characters you can select are shown below.

0	1	2	3	4	5	6	7	8	9
A	B	C	D	E	F	G	H	I	J
K	L	M	N	O	P	Q	R	S	T
U	V	W	X	Y	Z	\$	&	_	'
()	-	^	{	}	@	~	`	

- After the file name is the way you want, press the **31 (ENTER)** button.

This will display a confirmation message (SURE?).

 - If you want to cancel the renaming operation, press the **19 (NO)** or **23 (EXIT)** button.
- Press the **19 (YES)** button.
 - The message “Please Wait” will remain on the display while the rename operation is being performed. Do not perform any Digital Piano operation while this message is on the display. “Complete” appears on the display after renaming is complete.

Error Messages

One of the error messages below appears on the display when a problem occurs.

- All mentions of “memory card” in the following table refer to an SD memory card.

Display Message	Cause	Required Action
Format	<ol style="list-style-type: none"> 1. The current memory card format is not compatible with this Digital Piano. 2. The memory card capacity is greater than 2GB. 3. There is something wrong with the memory card. 	<ol style="list-style-type: none"> 1. Format the memory card on the Digital Piano (page E-46). 2. Use a memory card with a capacity of 2GB or less. 3. Use a different memory card.
MediaFull	<ol style="list-style-type: none"> 1. There is not enough room available on the memory card. 2. There is not enough room available in Digital Piano memory. 	<ol style="list-style-type: none"> 1. Delete some of the files on the memory card to make room for new data (page E-47), or use a different card. 2. Delete some or all user data from Digital Piano memory to make room for new data.
Media R/W	<ol style="list-style-type: none"> 1. Memory card data is corrupted. 2. Digital Piano memory is corrupted. 	<ol style="list-style-type: none"> 1. Use a different memory card. 2. Backup Digital Piano memory data by copying it to your computer, and then turn the Digital Piano off and then back on again. <ul style="list-style-type: none"> • Note that you may not be able to backup Digital Piano data in certain cases.
No Card	<ol style="list-style-type: none"> 1. The memory card is not loaded correctly in the Digital Piano’s memory card slot. 2. The memory card was removed while some operation was in progress. 	<ol style="list-style-type: none"> 1. Correctly load the memory card into the memory card slot. 2. Do not remove the memory card while any operation is in progress.
No File	<ol style="list-style-type: none"> 1. There is no MUSICDAT folder (page E-41) on the memory card. 2. There is no loadable or playable data in the MUSICDAT folder, or there is no playable data in a song playback folder (MUSIC__B, etc.) 	<ol style="list-style-type: none"> 1. Create a MUSICDAT folder on the memory card or format the memory card on the Digital Piano (page E-46). 2. Move the file you want to load or play into the memory card’s MUSICDAT folder. For song playback, you can place the song data into any one of the following folders: MUSIC__B, MUSIC__C, or MUSIC__D.
Not SMF01	You are attempting to play back SMF Format 2 song data.	This Digital Piano supports playback of SMF Format0 or Format1 only.
Protect	The memory card is write-protected.	Use the memory card’s write protect switch to enable writing.
ReadOnly	A read-only file with the same name you are trying to use is already stored on the memory card.	<ul style="list-style-type: none"> • Use a different name to save the new file. • Remove the read-only attribute from the existing file and overwrite it with the new file. • Use a different memory card.
SizeOver	The data on the memory card is too big to play.	This Digital Piano supports playback of song data files with a maximum size of 320 KB.
WrongDat	<ol style="list-style-type: none"> 1. The memory card data is corrupted. 2. The memory card contains data that is not supported by this Digital Piano. 	—

Connecting to a Computer

MASTER CONTROL CARD PLAYER

You can connect the Digital Piano to a computer and exchange MIDI data between them. You can send play data from the Digital Piano to music software running on your computer, or you can send MIDI data from your computer to the Digital Piano for playback.

Minimum Computer System Requirements

The following shows the minimum computer system requirements for sending and receiving MIDI data. Check to make sure that your computer complies with these requirements before connecting the Digital Piano to it.

● Operating System

Windows® XP (SP2 or later)*1

Windows Vista® *2

Windows® 7 *3

Mac OS® X (10.3.9, 10.4.11 or later, 10.5.6 or later, 10.6.2 or later)

*1 Windows XP Home Edition

Windows XP Professional (32-bit)

*2 Windows Vista (32-bit)

*3 Windows 7 (32-bit, 64-bit)

● USB port



IMPORTANT!

- Never connect to a computer that does not conform to the above requirements. Doing so can cause problems with your computer.

Connecting the Digital Piano to Your Computer



IMPORTANT!

- Make sure you follow the steps of the procedure below exactly. Connecting incorrectly can make data send and receive impossible.

1. Turn off the Digital Piano and then start up your computer.

- Do not start up the music software on your computer yet!

2. After starting up your computer, use a commercially available USB cable to connect it to the Digital Piano.

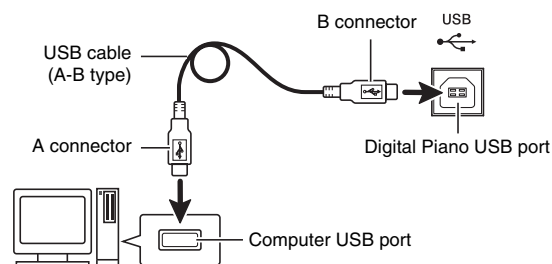

3. Turn on the Digital Piano.

- If this is the first time you are connecting the Digital Piano to your computer, the driver software required to send and receive data will be installed on your computer automatically.

4. Start up your computer's music software.

5. Configure the music software settings to select one of the following as the MIDI device.

CASIO USB-MIDI : (For Windows Vista, Windows 7, Mac OS X)

USB Audio Device: (For Windows XP)

- For information about how to select the MIDI device, see the user documentation that comes with the music software you are using.



IMPORTANT!

- Be sure to turn on the Digital Piano first before starting up your computer's music software.



NOTE

- Once you are able to connect successfully, there is no problem with leaving the USB cable connected when you turn off your computer and/or Digital Piano.
- This Digital Piano conforms to General MIDI Level 1 (GM).
- For detailed specifications and connections that apply to MIDI data send and receive by this Digital Piano, see the latest support information provided by the website at the following URL.
<http://world.casio.com/>

Transferring Data between the Digital Piano and a Computer

You can use the procedure below to transfer registration data from the Digital Piano to a computer for storage. You also can transfer standard MIDI files (SMF) from your computer to Digital Piano memory.

■ Data Types Supported for Data Transfer

Data Type	Description (File Name Extension)
MIDI files (page E-41)	One of the following two types of music data <ul style="list-style-type: none"> • CASIO format data (CM2) • Standard MIDI files (MID), SMF Format0 or Format1
Registration (page E-34)	Digital Piano setups (CB6, CR6)

IMPORTANT!

- Turning off the Digital Piano while data is being transferred can cause all data currently stored in Digital Piano memory to be deleted. Take care so power is not turned off accidentally during data transfer operations. If data is deleted, it will take longer than normal for the Digital Piano to power up the next time you turn it on (page E-11).

1. Remove the memory card from the Digital Piano's memory card slot (page E-46).
 - You will not be able to transfer data between the Digital Piano and a computer if a card is in the memory card slot.
2. Perform steps 1 through 3 under "Connecting the Digital Piano to Your Computer" to connect the piano to your computer (page E-49).

3. While holding down the **18 (FUNCTION)** button, press the **32 (USB DEVICE MODE)** button.

This will enter the storage mode, which enables data transfer with the connected computer. The **18 (FUNCTION)** button lamp will flash and the display will appear as shown below.

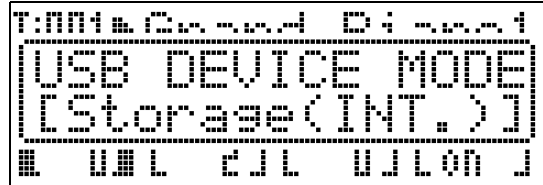

- To exit the storage mode at any time, press the **18 (FUNCTION)** button. This is the only button operation that is supported while the Digital Piano is in the storage mode.
- You will not be able to enter the storage mode while any one of the following operations is in progress. MIDI file playback, data transfer between the Digital Piano and card

4. If your computer is running Windows XP, double-click "My Computer". *

Under "Devices with Removable Storage", you should be able to see an icon representing Digital Piano memory or the memory card loaded in the Digital Piano (see below).

- * Windows Vista, Windows 7: Double-click "Computer".
Mac OS: Skip step 4 and double-click "PIANO" on your Mac desktop.

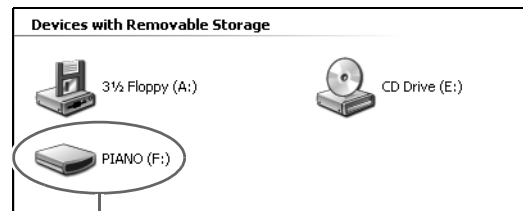

PIANO drive (Digital Piano memory)

5. Double-click "PIANO".

You now should see the folders below.

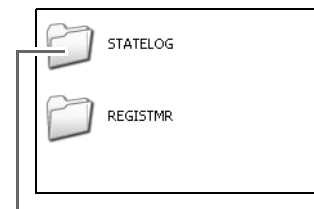

This folder is not a data folder. You should not try to use it for normal Digital Piano operation.

6. File name extensions (.MID, .CM2, etc.) are not displayed under initial default Windows settings. Perform the procedure below to turn on display of file name extensions.

- (1) Perform one of the following operations to display folder information.
 - Windows XP:
On the [Tools] menu at the top of the folder window, select [Folder Options].
 - Windows Vista, Windows 7:
On the left side of the folder window, click [Organize] and then select [Folder and Search Options].
- (2) On the Folder Information window, click the [View] tab.
- (3) Under "Advanced Settings", clear the "Hide extensions for known file types" check box and then click [OK].

7. Perform one of the following operations to transfer data.

- 7-1. To transfer data from Digital Piano memory to a computer, perform the required operation on your computer to copy the data from Digital Piano memory to another location on your computer.
- 7-2. To load a MIDI file (.MID or .CM2) from your computer to Digital Piano memory, copy the file you want to load to the root directory of "PIANO" drive.
- 7-3. To load a registration data file (.CB6 or .CR6) from your computer to Digital Piano memory, copy the file you want to load to the "REGISTMR" folder.

8. Press the **F** (FUNCTION) button to exit the storage mode.

- If you are using a Macintosh, drag the PIANO folder to the Trash and then press the Digital Piano's **F** (FUNCTION) button.



IMPORTANT!

- The message "ERROR, DATA EXCHANGE" will appear on the display if a problem occurs during data transfer. If this happens, check the message in the "STATELOG" folder (page E-50) on the "PIANO" drive. Next find the same message in the table on page E-48 of this manual to determine the cause of the problem and what action you need to take to avoid it.

Using Your Digital Piano as a Memory Card Reader

You can display the contents of the memory card currently loaded in the Digital Piano's card slot and perform copy, delete, and other card operations from your computer.

- 1.** Insert the memory card into the Digital Piano's memory card slot.
- 2.** Perform the procedure starting from step 2 on page E-50.

In step 4 of the procedure, "SD_MMC" will appear in place of "PIANO". You can double-click "SD_MMC" to display the contents of the card loaded in the Digital Piano card slot, and change it as you like.

Copyrights

The rights of creators and copyright holders of music, images, computer programs, databases, and other data are protected by copyright laws. You are allowed to reproduce such works for personal or non-commercial use only. For any other purpose, all reproduction (including data format conversion), modification, transfer of reproductions, distribution over a network, or any other use without permission of the copyright holder exposes you to claims for damages and criminal prosecution for copyright infringement and violation of the author's personal rights. Be sure to reproduce and otherwise use copyrighted works only in accordance with applicable copyright laws.

Reference

Troubleshooting

Problem	Cause	Action	See Page
Nothing comes out of the connected headphones or amplifier speakers when I play something.	The 1 (VOLUME) knob is set to "MIN".	Rotate the 1 (VOLUME) knob more towards "MAX".	☞ E-11
	The UPPER 1 zone setting is INT OFF.	Change the UPPER 1 zone setting to INT ON. If you are using Layer and/or Split, change the setting of the zone you are using to INT ON.	☞ E-27
The pitch of the Digital Piano is off.	The Digital Piano's key setting is something other than 0.	Change the key setting to 0, or turn Digital Piano power off and then back on again.	☞ E-20
	Digital Piano tuning is incorrect.	Adjust Digital Piano tuning, or turn Digital Piano power off and then back on again.	☞ E-39
	The Coarse Tuning and/or Fine Tuning setting is something other than 0.	Change the setting(s) to 0 or turn Digital Piano power off and then back on.	☞ E-31
	A non-standard temperament setting is being used.	Change the temperament setting to "00:Equal", which is the standard modern tuning.	☞ E-39
	Octave shift is enabled.	Change the octave shift setting to 0.	☞ E-30
Tones and/or effects sound strange. Turning power off and then back on again does not eliminate the problem. <i>Example: Note intensity does not change even though I alter key pressure.</i>	The "Backup" feature is turned on.	Turn off "Backup". Next, turn power off and then back on again.	☞ E-40
I cannot hear any chorus/reverb effect when I turn on chorus/reverb.	The chorus send/reverb send setting is 0.	Change the chorus send/reverb send setting to a greater value.	☞ E-32
I cannot play back a music file from an SD card.	The file you are trying to play is not a format supported by this Digital Piano.	This Digital Piano supports playback of Format0 or Format1 SMF files, or CM2 (CASIO proprietary format) files only. Playback of WAV and MP3 files, or other format MIDI files is not supported.	☞ E-41
I cannot transfer data after connecting the Digital Piano to a computer.	—	<ul style="list-style-type: none"> • Check to make sure that the USB cable is connected to the Digital Piano and computer, and that the correct device is selected with your computer's music software. • Turn off the Digital Piano and then exit the music software on your computer. Next, turn the Digital Piano back on and then restart the music software on your computer. 	☞ E-49
	—		
I cannot store data to a memory card or load data from a memory card.	—	See "Error Messages" on page E-48.	—
Playback stops part way through while transferring song data from my computer.	Digital noise from the USB cable or power cord caused data communication between your computer and Digital Piano to be interrupted.	<p>Stop song playback, disconnect the USB cable from the Digital Piano, and then reconnect it. Next, try playing back the song again.</p> <p>If this does not solve the problem, quit the MIDI software you are using, disconnect the USB cable from the Digital Piano, and then reconnect it. Next, restart the MIDI software and then try playing back the song again.</p>	☞ E-49

Problem	Cause	Action	See Page
A tone's quality and volume sounds slightly different depending where it is played on the keyboard.	<p>This is an unavoidable result of the digital sampling process,* and does not indicate malfunction.</p> <p>* Multiple digital samples are taken for the low range, middle range, and high range of the original musical instrument. Because of this, there may be a very slight difference in tonal quality and volume between sample ranges.</p>		
When I press a button, the note that is sounding cuts out momentarily or there is a slight change in how effects are applied.	<p>Performing a button operation while playing back a MIDI file can cause such phenomena when the Digital Piano switches internal tone effects. It does not indicate malfunction.</p>		
Even though I play on different ranges of the keyboard, the notes do not change octaves.	<p>The ranges of certain tones are limited, which means that octaves change normally up to a certain low note or high note. With such a tone, the notes of the lowest octave will be repeated to the left of the lowest possible note, and the highest octave will be repeated to the right of the highest possible note. This is due to limitations in the range of the original musical instrument for each tone, and does not indicate malfunction of the Digital Piano.</p>		

Product Specifications

Model	PX-3SBK
Keyboard	88-key piano keyboard, with Touch Response (3 types)
Maximum Polyphony	128 notes
Tones	250 (with Layer and Split)
Effects	DSP, Reverb (4 types), Chorus (4 types), Brilliance (-3 to 0 to 3), Acoustic Resonance
Mixer	UPPER 1, UPPER 2, LOWER 1, LOWER 2; the volume level of each zone can be adjusted independently.
Assignable buttons	2
Demo Songs	4 original songs (played back sequentially and repeatedly)
Registration	8 areas × 8 banks
Pedals	Damper, Soft/Sostenuto (switchable)
Other Functions	<ul style="list-style-type: none"> • Transpose: ±1 octave (-12 to 0 to 12) • Tuning: A4 = 440.0 Hz ±99 cents • Octave Shift: ±2 octaves • Temperaments: 17 types • Stretch Tune • Panel Lock
MIDI	16 multi-timbre received, GM Level 1 standard
Pitch Bend Wheel	Pitch Bend Range: 00 to 12 semitones
SD Memory Card	<ul style="list-style-type: none"> • SD memory card slot • Supported SD Memory Cards: Up to 2GB • Functions: SMF playback, file storage, file recall, card format
Inputs/Outputs	<ul style="list-style-type: none"> • PHONES jacks: Stereo mini jacks × 2 • Pedal Jacks: Standard jacks × 2 • MIDI OUT/IN terminals • LINE OUT R, L/MONO jacks: Standard jacks × 2 Output impedance: 2.3KΩ Output voltage: 1.8V (RMS) MAX • LINE IN R, L/MONO jacks: Standard jacks × 2 Input impedance: 9.0KΩ Input voltage: 200mV • Power: 12V DC • USB port: Type B • Pedal connector (for optional SP-32 only)
Power Requirements	AC Adaptor: AD-A12150LW
Power Consumption	12V --- 18W
Dimensions	132.2 (W) × 28.6 (D) × 13.5 (H) cm (52 1/16 × 11 1/4 × 5 5/16 inch)
Weight	Approximately 10.8kg (23.8lbs)

* Based on 1KB = 1024bytes, 1MB = 1024² bytes

- Specifications and designs are subject to change without notice.

Operating Precautions

Be sure to read and observe the following operating precautions.

■ Location

Avoid the following locations for this product.

- Areas exposed to direct sunlight and high humidity
- Areas subjected to temperature extremes
- Near a radio, TV, video deck, or tuner
- The above devices will not cause malfunction of the product, but the product can cause interference in the audio or video of a nearby device.

■ Setup Generated Distortion

Though the DSP and equalizer functions of the Digital Piano let you apply various effects to built-in tones, certain setting combinations may result in distortion of notes.

■ User Maintenance

- Never use benzine, alcohol, thinner, or other chemical agents to clean the product.
- To clean the product or its keyboard, wipe with a soft cloth moistened in a weak solution of water and a mild neutral detergent. Wring all excess moisture from the cloth before wiping.

■ Included and Optional Accessories

Use only accessories that are specified for use with this product. Use of unauthorized accessories creates the risk of fire, electric shock, and personal injury.

■ Weld Lines

Lines may be visible on the exterior of the product. These are "weld lines" that result from the plastic molding process. They are not cracks or scratches.

■ Musical Instrument Etiquette

Always be aware of others around you whenever using this product. Be especially careful when playing late at night to keep the volume at levels that do not disturb others. Other steps you can take when playing late at night are closing windows and using headphones.

- Any reproduction of the contents of this manual, either in part or its entirety, is prohibited. Except for your own, personal use, any other use of the contents of this manual without the consent of CASIO is prohibited under copyright laws.
- IN NO EVENT SHALL CASIO BE LIABLE FOR ANY DAMAGES WHATSOEVER (INCLUDING, WITHOUT LIMITATION, DAMAGES FOR LOSS OF PROFITS, BUSINESS INTERRUPTION, LOSS OF INFORMATION) ARISING OUT OF THE USE OF OR INABILITY TO USE THIS MANUAL OR PRODUCT, EVEN IF CASIO HAS BEEN ADVISED OF THE POSSIBILITY OF SUCH DAMAGES.
- The contents of this manual are subject to change without notice.

■ AC Adaptor Handling Precautions

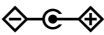
- Use a power outlet that is easily accessible so you can unplug the AC adaptor when a malfunction occurs or whenever else you need to do so.
- The AC adaptor is intended for indoor use only. Do not use it where it might be exposed to splashing or moisture. Do not place any container, such as a flower vase, that contains liquid on the AC adaptor.
- Store the AC adaptor in a dry place.
- Use the AC adaptor in an open, well-ventilated area.
- Never cover the AC adaptor with newspaper, a table cloth, a curtain, or any other similar item.
- Unplug the AC adaptor from the power outlet if you do not plan to use the Digital Piano for a long time.
- Never try to repair the AC adaptor or modify it in any way.
- AC adaptor operating environment
 - Temperature: 0 to 40°C
 - Humidity: 10% to 90% RH
- Output polarity: 

AC Adaptor Handling Precautions

Model: AD-A12150LW

1. Read these instructions.
2. Keep these instructions on hand.
3. Heed all warnings.
4. Follow all instructions.
5. Do not use this product near water.
6. Clean only with a dry cloth.
7. Do not install near radiators, heat registers, stoves, or any other source of heat (including amplifiers).
8. Use only attachments and accessories specified by the manufacturer.
9. Refer all servicing to qualified service personnel. Servicing is required after any of the following occurs: when the product is damaged, when the power supply cord or plug is damaged, when liquid is spilled into the product, when a foreign object falls into the product, when the product is exposed to rain or moisture, when the product does not operate normally, when the product is dropped.
10. Do not allow the product to be exposed to dripping or splashing liquid. Do not place any object containing liquid on the product.
11. Do not allow the electrical load output to exceed the label rating.
12. Make sure the surrounding area is dry before plugging into a power source.
13. Make sure the product is oriented correctly.
14. Unplug the product during lightning storms or when you do not plan to use it for a long time.
15. Do not allow product ventilation openings to become blocked. Install the product in accordance with the manufacturer's instructions.
16. Take care the power cord is located where it will not be stepped upon or bent severely, particularly in locations close to plugs and convenience receptacles, and in locations where it exits from the product.
17. The AC adaptor should be plugged into a power outlet as close to the product as possible to allow immediate disconnection of the plug in case of emergency.

The symbol below is an alert indicating un-insulated hazardous voltage inside the product's enclosure, which may be sufficient to constitute the risk of electric shock to users.



The symbol below is an alert indicating the presence of important operating and maintenance (servicing) instructions in the documentation that accompanies the product.



Appendix

Tone List

Sequential Number	Group Name	Group Number	Tone Name	Program Change	Bank Select MSB	DSP Algorithm
01	PIANO	001	GRAND PIANO 1	0	48	Equalizer
02	PIANO	002	GRAND PIANO 2	0	49	—
03	PIANO	003	ROCK PIANO	1	48	—
04	PIANO	004	MELLOW PIANO	0	50	Equalizer
05	PIANO	005	BRIGHT PIANO	1	49	Equalizer
06	PIANO	006	MONO PIANO 1	0	51	—
07	PIANO	007	MONO PIANO 2	0	52	—
08	PIANO	008	LA PIANO	1	50	Equalizer
09	PIANO	009	COMP.PIANO	0	53	Compressor
10	PIANO	010	DANCE PIANO	1	51	Equalizer
11	PIANO	011	STRINGS PIANO	0	54	Enhancer
12	PIANO	012	PIANO PAD	0	55	Enhancer
13	PIANO	013	HONKY-TONK	3	48	—
14	PIANO	014	OCTAVE PIANO	3	49	—
15	PIANO	015	HARPSICHORD	6	48	—
16	PIANO	016	COUPLED HARPSICHORD	6	49	—
17	ELEC PIANO 1	001	ELEC.PIANO 1	4	48	Stereo Phaser
18	ELEC PIANO 1	002	ELEC.PIANO PURE	4	49	—
19	ELEC PIANO 1	003	ELEC.PIANO 2	4	50	3-Phase Chorus
20	ELEC PIANO 1	004	DYNO ELEC.PIANO	4	51	—
21	ELEC PIANO 1	005	60'S E.PIANO	4	52	—
22	ELEC PIANO 1	006	PHASER EP	4	53	Stereo Phaser
23	ELEC PIANO 1	007	TREMOLO EP	4	54	Phaser - Auto Pan
24	ELEC PIANO 1	008	COMP.EP	4	55	Compressor
25	ELEC PIANO 1	009	WAH EP	4	56	Auto Wah
26	ELEC PIANO 1	010	PHASER 60'S EP	4	57	Stereo Phaser
27	ELEC PIANO 1	011	TREMOLO 60'S EP	4	58	Auto Pan
28	ELEC PIANO 1	012	STRINGS EP	4	59	—
29	ELEC PIANO 2	001	FM E.PIANO 1	5	49	—
30	ELEC PIANO 2	002	FM E.PIANO 2	5	48	—
31	ELEC PIANO 2	003	CHORUS EP	5	50	Phaser - Chorus
32	ELEC PIANO 2	004	MELLOW E.PIANO	5	51	Stereo Phaser
33	ELEC PIANO 2	005	POP ELEC.PIANO	5	52	Enhancer
34	ELEC PIANO 2	006	SYNTH-STR.EP	5	53	—
35	ELEC PIANO 2	007	ELEC.GRAND 1	2	48	—
36	ELEC PIANO 2	008	ELEC.GRAND 2	2	49	Stereo Phaser
37	CLAVI/VIBES	001	CLAVI 1	7	48	—
38	CLAVI/VIBES	002	CLAVI 2	7	49	—
39	CLAVI/VIBES	003	WAH CLAVI	7	50	Auto Wah
40	CLAVI/VIBES	004	PHASER CLAVI	7	51	Stereo Phaser
41	CLAVI/VIBES	005	COMP.CLAVI	7	52	Compressor
42	CLAVI/VIBES	006	VIBRAPHONE	11	48	—
43	CLAVI/VIBES	007	TREMOLO VIBES	11	49	Tremolo
44	CLAVI/VIBES	008	MARIMBA	12	48	—
45	ORGAN	001	JAZZ ORGAN 1	17	48	Rotary
46	ORGAN	002	JAZZ ORGAN 2	17	49	Rotary
47	ORGAN	003	ROCK ORGAN 1	18	48	Drive Rotary
48	ORGAN	004	ROCK ORGAN 2	18	49	Rotary
49	ORGAN	005	PERC.ORGAN 1	17	50	Rotary
50	ORGAN	006	PERC.ORGAN 2	17	51	Rotary
51	ORGAN	007	PERC.ORGAN 3	17	52	Rotary
52	ORGAN	008	DRAWBAR ORGAN 1	16	48	Rotary
53	ORGAN	009	DRAWBAR ORGAN 2	16	49	Rotary
54	ORGAN	010	DRAWBAR ORGAN 3	16	50	Rotary
55	ORGAN	011	ELEC.ORGAN 1	16	51	Rotary
56	ORGAN	012	ELEC.ORGAN 2	16	52	Rotary
57	ORGAN	013	ELEC.ORGAN 3	16	53	Rotary
58	ORGAN	014	70'S ORGAN	17	53	Rotary
59	ORGAN	015	OVERDRIVE ORGAN	16	54	Distortion
60	ORGAN	016	TREMOLO ORGAN	16	55	Auto Pan
61	ORGAN	017	CHURCH ORGAN	19	48	—
62	ORGAN	018	CHAPEL ORGAN	19	49	—
63	STRINGS/ ENSEMBLE	001	STEREO STRINGS	48	48	Early Reflection
64	STRINGS/ ENSEMBLE	002	STRINGS	48	49	—
65	STRINGS/ ENSEMBLE	003	WARM STRINGS	48	50	—
66	STRINGS/ ENSEMBLE	004	STRING ENSEMBLE	48	51	—
67	STRINGS/ ENSEMBLE	005	SLOW STRINGS	49	48	—
68	STRINGS/ ENSEMBLE	006	SYNTH-STRINGS 1	50	48	Equalizer

Sequential Number	Group Name	Group Number	Tone Name	Program Change	Bank Select MSB	DSP Algorithm
69	STRINGS/ ENSEMBLE	007	SYNTH-STRINGS 2	51	48	Stereo Phaser
70	STRINGS/ ENSEMBLE	008	70'S SYNTH-STR.	50	49	—
71	STRINGS/ ENSEMBLE	009	80'S SYNTH-STR.	50	50	—
72	STRINGS/ ENSEMBLE	010	VIOLIN SECTION	49	49	—
73	STRINGS/ ENSEMBLE	011	ORCHESTRA PAD	48	52	Early Reflection
74	STRINGS/ ENSEMBLE	012	CHOIR	52	48	—
75	STRINGS/ ENSEMBLE	013	SYNTH-VOICE	54	48	—
76	STRINGS/ ENSEMBLE	014	VOICE PAD	54	49	Phaser
77	STRINGS/ ENSEMBLE	015	WARM PAD	89	48	—
78	STRINGS/ ENSEMBLE	016	WARM VOX	89	49	—
79	STRINGS/ ENSEMBLE	017	FANTASY	88	48	—
80	STRINGS/ ENSEMBLE	018	NEW AGE	88	49	Equalizer
81	STRINGS/ ENSEMBLE	019	POLYSYNTH PAD	90	48	—
82	STRINGS/ ENSEMBLE	020	ATMOSPHERE PAD	99	48	—
83	GUITAR/BASS	001	STEEL STR.GUITAR 1	25	48	—
84	GUITAR/BASS	002	NYLON STR.GUITAR	24	48	—
85	GUITAR/BASS	003	12 STR.GUITAR	25	49	—
86	GUITAR/BASS	004	JAZZ GUITAR	26	48	Compressor - Chorus
87	GUITAR/BASS	005	CLEAN GUITAR	27	48	Compressor - Phaser
88	GUITAR/BASS	006	DISTORTION GT	29	48	Compressor - Distortion - Auto Pan
89	GUITAR/BASS	007	ACOUSTIC BASS	32	48	—
90	GUITAR/BASS	008	RIDE BASS	32	49	—
91	GUITAR/BASS	009	FINGERED BASS	33	48	—
92	GUITAR/BASS	010	FRETLESS BASS	35	48	—
93	OTHERS/GM	001	STEREO BRASS	61	48	Early Reflection
94	OTHERS/GM	002	BRASS SECTION	61	49	—
95	OTHERS/GM	003	SYNTH-BRASS 1	62	48	—
96	OTHERS/GM	004	SYNTH-BRASS 2	63	48	—
97	OTHERS/GM	005	80'S SYNTH-BRASS	62	49	—
98	OTHERS/GM	006	SQUARE LEAD 1	80	48	Early Reflection
99	OTHERS/GM	007	SQUARE LEAD 2	80	49	—
100	OTHERS/GM	008	SAW LEAD 1	81	48	Early Reflection
101	OTHERS/GM	009	SAW LEAD 2	81	49	—
102	OTHERS/GM	010	SAW LEAD 3	81	50	—
103	OTHERS/GM	011	MELLOW SAW LEAD	81	51	—
104	OTHERS/GM	012	PULSE LEAD 1	80	50	—
105	OTHERS/GM	013	PULSE LEAD 2	80	51	—
106	OTHERS/GM	014	SINE LEAD	80	52	—
107	OTHERS/GM	015	ALTO SAX	65	48	—
108	OTHERS/GM	016	TENOR SAX	66	48	—
109	OTHERS/GM	017	BREATHY ALTO SAX	65	49	—
110	OTHERS/GM	018	CLARINET	71	48	—
111	OTHERS/GM	019	FLUTE	73	48	—
112	OTHERS/GM	020	TRUMPET	56	48	Enhancer
113	OTHERS/GM	021	GM PIANO 1	0	0	—
114	OTHERS/GM	022	GM PIANO 2	1	0	—
115	OTHERS/GM	023	GM PIANO 3	2	0	—
116	OTHERS/GM	024	GM HONKY-TONK	3	0	—
117	OTHERS/GM	025	GM E.PIANO 1	4	0	—
118	OTHERS/GM	026	GM E.PIANO 2	5	0	—
119	OTHERS/GM	027	GM HARPSICHORD	6	0	—
120	OTHERS/GM	028	GM CLAVI	7	0	—
121	OTHERS/GM	029	GM CELESTA	8	0	—
122	OTHERS/GM	030	GM GLOCKENSPIEL	9	0	—
123	OTHERS/GM	031	GM MUSIC BOX	10	0	—
124	OTHERS/GM	032	GM VIBRAPHONE	11	0	—
125	OTHERS/GM	033	GM MARIMBA	12	0	—
126	OTHERS/GM	034	GM XYLOPHONE	13	0	—
127	OTHERS/GM	035	GM TUBULAR BELL	14	0	—
128	OTHERS/GM	036	GM DULCIMER	15	0	—

Sequential Number	Group Name	Group Number	Tone Name	Program Change	Bank Select MSB	DSP Algorithm
129	OTHERS/GM	037	GM ORGAN 1	16	0	-
130	OTHERS/GM	038	GM ORGAN 2	17	0	-
131	OTHERS/GM	039	GM ORGAN 3	18	0	-
132	OTHERS/GM	040	GM PIPE ORGAN	19	0	-
133	OTHERS/GM	041	GM REED ORGAN	20	0	-
134	OTHERS/GM	042	GM ACCORDION	21	0	-
135	OTHERS/GM	043	GM HARMONICA	22	0	-
136	OTHERS/GM	044	GM BANDONEON	23	0	-
137	OTHERS/GM	045	GM NYLON STR.GUITAR	24	0	-
138	OTHERS/GM	046	GM STEEL STR.GUITAR	25	0	-
139	OTHERS/GM	047	GM JAZZ GUITAR	26	0	-
140	OTHERS/GM	048	GM CLEAN GUITAR	27	0	-
141	OTHERS/GM	049	GM MUTE GUITAR	28	0	-
142	OTHERS/GM	050	GM OVERDRIVE GT	29	0	-
143	OTHERS/GM	051	GM DISTORTION GT	30	0	-
144	OTHERS/GM	052	GM GT HARMONICS	31	0	-
145	OTHERS/GM	053	GM ACOUSTIC BASS	32	0	-
146	OTHERS/GM	054	GM FINGERED BASS	33	0	-
147	OTHERS/GM	055	GM PICKED BASS	34	0	-
148	OTHERS/GM	056	GM FRETLESS BASS	35	0	-
149	OTHERS/GM	057	GM SLAP BASS 1	36	0	-
150	OTHERS/GM	058	GM SLAP BASS 2	37	0	-
151	OTHERS/GM	059	GM SYNTH-BASS 1	38	0	-
152	OTHERS/GM	060	GM SYNTH-BASS 2	39	0	-
153	OTHERS/GM	061	GM VIOLIN	40	0	-
154	OTHERS/GM	062	GM VIOLA	41	0	-
155	OTHERS/GM	063	GM CELLO	42	0	-
156	OTHERS/GM	064	GM CONTRABASS	43	0	-
157	OTHERS/GM	065	GM TREMOLO STRINGS	44	0	-
158	OTHERS/GM	066	GM PIZZICATO	45	0	-
159	OTHERS/GM	067	GM HARP	46	0	-
160	OTHERS/GM	068	GM TIMPANI	47	0	-
161	OTHERS/GM	069	GM STRINGS 1	48	0	-
162	OTHERS/GM	070	GM STRINGS 2	49	0	-
163	OTHERS/GM	071	GM SYNTH-STRINGS 1	50	0	-
164	OTHERS/GM	072	GM SYNTH-STRINGS 2	51	0	-
165	OTHERS/GM	073	GM CHOIR AAHS	52	0	-
166	OTHERS/GM	074	GM VOICE DOO	53	0	-
167	OTHERS/GM	075	GM SYNTH-VOICE	54	0	-
168	OTHERS/GM	076	GM ORCHESTRA HIT	55	0	-
169	OTHERS/GM	077	GM TRUMPET	56	0	-
170	OTHERS/GM	078	GM TROMBONE	57	0	-
171	OTHERS/GM	079	GM TUBA	58	0	-
172	OTHERS/GM	080	GM MUTE TRUMPET	59	0	-
173	OTHERS/GM	081	GM FRENCH HORN	60	0	-
174	OTHERS/GM	082	GM BRASS	61	0	-
175	OTHERS/GM	083	GM SYNTH-BRASS 1	62	0	-
176	OTHERS/GM	084	GM SYNTH-BRASS 2	63	0	-
177	OTHERS/GM	085	GM SOPRANO SAX	64	0	-
178	OTHERS/GM	086	GM ALTO SAX	65	0	-
179	OTHERS/GM	087	GM TENOR SAX	66	0	-
180	OTHERS/GM	088	GM BARITONE SAX	67	0	-
181	OTHERS/GM	089	GM OBOE	68	0	-
182	OTHERS/GM	090	GM ENGLISH HORN	69	0	-
183	OTHERS/GM	091	GM BASSOON	70	0	-
184	OTHERS/GM	092	GM CLARINET	71	0	-
185	OTHERS/GM	093	GM PICCOLO	72	0	-
186	OTHERS/GM	094	GM FLUTE	73	0	-
187	OTHERS/GM	095	GM RECORDER	74	0	-
188	OTHERS/GM	096	GM PAN FLUTE	75	0	-
189	OTHERS/GM	097	GM BOTTLE BLOW	76	0	-
190	OTHERS/GM	098	GM SHAKUHACHI	77	0	-
191	OTHERS/GM	099	GM WHISTLE	78	0	-
192	OTHERS/GM	100	GM OCARINA	79	0	-
193	OTHERS/GM	101	GM SQUARE LEAD	80	0	-
194	OTHERS/GM	102	GM SAW LEAD	81	0	-
195	OTHERS/GM	103	GM CALLIOPE	82	0	-
196	OTHERS/GM	104	GM CHIFF LEAD	83	0	-
197	OTHERS/GM	105	GM CHARANG	84	0	-
198	OTHERS/GM	106	GM VOICE LEAD	85	0	-
199	OTHERS/GM	107	GM FIFTH LEAD	86	0	-
200	OTHERS/GM	108	GM BASS+LEAD	87	0	-
201	OTHERS/GM	109	GM FANTASY	88	0	-
202	OTHERS/GM	110	GM WARM PAD	89	0	-
203	OTHERS/GM	111	GM POLYSYNTH	90	0	-
204	OTHERS/GM	112	GM SPACE CHOIR	91	0	-
205	OTHERS/GM	113	GM BOWED GLASS	92	0	-
206	OTHERS/GM	114	GM METAL PAD	93	0	-
207	OTHERS/GM	115	GM HALO PAD	94	0	-
208	OTHERS/GM	116	GM SWEEP PAD	95	0	-

Sequential Number	Group Name	Group Number	Tone Name	Program Change	Bank Select MSB	DSP Algorithm
209	OTHERS/GM	117	GM RAIN DROP	96	0	-
210	OTHERS/GM	118	GM SOUND TRACK	97	0	-
211	OTHERS/GM	119	GM CRYSTAL	98	0	-
212	OTHERS/GM	120	GM ATMOSPHERE	99	0	-
213	OTHERS/GM	121	GM BRIGHTNESS	100	0	-
214	OTHERS/GM	122	GM GOBLINS	101	0	-
215	OTHERS/GM	123	GM ECHOES	102	0	-
216	OTHERS/GM	124	GM SF	103	0	-
217	OTHERS/GM	125	GM SITAR	104	0	-
218	OTHERS/GM	126	GM BANJO	105	0	-
219	OTHERS/GM	127	GM SHAMISEN	106	0	-
220	OTHERS/GM	128	GM KOTO	107	0	-
221	OTHERS/GM	129	GM THUMB PIANO	108	0	-
222	OTHERS/GM	130	GM BAGPIPE	109	0	-
223	OTHERS/GM	131	GM FIDDLE	110	0	-
224	OTHERS/GM	132	GM SHANAI	111	0	-
225	OTHERS/GM	133	GM TINKLE BELL	112	0	-
226	OTHERS/GM	134	GM AGOGO	113	0	-
227	OTHERS/GM	135	GM STEEL DRUMS	114	0	-
228	OTHERS/GM	136	GM WOOD BLOCK	115	0	-
229	OTHERS/GM	137	GM TAIKO	116	0	-
230	OTHERS/GM	138	GM MELODIC TOM	117	0	-
231	OTHERS/GM	139	GM SYNTH-DRUM	118	0	-
232	OTHERS/GM	140	GM REVERSE CYMBAL	119	0	-
233	OTHERS/GM	141	GM GT FRET NOISE	120	0	-
234	OTHERS/GM	142	GM BREATH NOISE	121	0	-
235	OTHERS/GM	143	GM SEASHORE	122	0	-
236	OTHERS/GM	144	GM BIRD	123	0	-
237	OTHERS/GM	145	GM TELEPHONE	124	0	-
238	OTHERS/GM	146	GM HELICOPTER	125	0	-
239	OTHERS/GM	147	GM APPLAUSE	126	0	-
240	OTHERS/GM	148	GM GUNSHOT	127	0	-
241	OTHERS/GM	149	STANDARD SET 1	0	120	-
242	OTHERS/GM	150	STANDARD SET 2	1	120	-
243	OTHERS/GM	151	ROOM SET	8	120	-
244	OTHERS/GM	152	POWER SET	16	120	-
245	OTHERS/GM	153	ELECTRONIC SET	24	120	-
246	OTHERS/GM	154	SYNTH SET 1	25	120	-
247	OTHERS/GM	155	SYNTH SET 2	30	120	-
248	OTHERS/GM	156	JAZZ SET	32	120	-
249	OTHERS/GM	157	BRUSH SET	40	120	-
250	OTHERS/GM	158	ORCHESTRA SET	48	120	-

 **NOTE**

- See the “Drum Assignment List” (page E-59) for the percussion instrument assigned to each keyboard key when a drum set (Sequential Number 241 to 250) is selected.

Drum Assignment List

Key/Note Number	STANDARD SET 1	STANDARD SET 2	ROOM SET	POWER SET	ELECTRONIC SET	SYNTH SET 1	SYNTH SET 2	JAZZ SET	BRUSH SET	ORCHESTRA SET
E1 28	High Q	←	←	←	←	←	←	←	←	Closed Hi-Hat
F1 29	Slap	←	←	←	←	←	←	←	←	Pedal Hi-Hat
G1 31	Scratch Push	←	←	←	←	←	←	←	←	Open Hi-Hat
A1 33	Scratch Pull	←	←	←	←	←	←	←	←	Ride Cymbal 1
B1 34	Sticks	←	←	←	←	←	←	←	←	←
C1 35	Square Click	←	←	←	←	←	←	←	←	←
D1 36	Metronome Click	←	←	←	←	←	←	←	←	←
E1 37	Standard1 Kick 2	←	←	←	←	←	←	←	←	←
F1 38	Standard1 Kick 1	Standard2 Kick 2	Room Kick 2	Power Kick 2	Elec. Kick 2	Synth1 Kick 2	Synth2 Kick 2	Jazz Kick 2	Jazz Kick 2	Jazz Kick 1
G1 39	Standard1 Snare 1	Standard2 Kick 1	Room Kick 1	Power Kick 1	Elec. Kick 1	Synth1 Kick 1	Synth2 Kick 1	Jazz Kick 1	Brush Kick	Concert BD
A1 40	Standard1 Snare 2	Standard2 Snare 1	Room Snare 1	Power Snare 1	Elec. Snare 1	Synth1 Snare 1	Synth2 Snare 1	Jazz Snare 1	Brush Side Stick	Concert SD
B1 41	Hand Clap	Standard2 Snare 2	Room Snare 2	Power Snare 2	Elec. Snare 2	Synth1 Snare 2	Synth2 Snare 2	Jazz Snare 2	Brush Snare 1	Concert SD
C1 42	Standard1 Snare 2	Standard2 Snare 2	Room Low Tom 2	Room Low Tom 2	Elec. Low Tom 2	Synth1 Low Tom 2	Synth2 Low Tom 2	Jazz Snare 2	Brush Snare 2	Casareis
D1 43	Closed Hi-Hat	Standard2 Closed Hi-Hat	Room Low Tom 1	Room Low Tom 1	Elec. Low Tom 1	Synth1 Low Tom 1	Synth2 Low Tom 1	←	←	Concert SD
E1 44	Pedal Hi-Hat	Standard2 Pedal Hi-Hat	Room Mid Tom 2	Room Mid Tom 2	Elec. Mid Tom 2	Synth1 Closed Hi-Hat 2	Synth2 Closed Hi-Hat 2	←	←	Timpani F#
F1 45	Low Tom 2	Standard2 Open Hi-Hat	Room Mid Tom 1	Room Mid Tom 1	Elec. Mid Tom 1	Synth1 Open Hi-Hat 2	Synth2 Open Hi-Hat 2	←	←	Timpani G
G1 46	Mid Tom 2	Standard2 Open Hi-Hat	Room High Tom 2	Room High Tom 2	Elec. High Tom 2	Synth1 Mid Tom 1	Synth2 Mid Tom 1	←	←	Timpani A#
A1 47	Open Hi-Hat	Standard2 Open Hi-Hat	Room High Tom 1	Room High Tom 1	Elec. High Tom 1	Synth1 High Tom 1	Synth2 High Tom 1	←	←	Timpani A
B1 48	Crash Cymbal 1	←	←	←	←	Synth1 Crash Cymbal	←	←	←	Timpani B#
C1 49	High Tom 1	←	←	←	←	Synth1 High Tom 1	←	←	←	Timpani C
D1 50	Ride Cymbal 1	←	←	←	←	Synth1 Ride Cymbal	←	←	←	Timpani d#
E1 51	Chinese Cymbal	←	←	←	←	←	←	←	←	Timpani d
F1 52	Ride Bell	←	←	←	←	←	←	←	←	Timpani e
G1 53	Tambourine	←	←	←	←	←	←	←	←	Timpani f
A1 54	Splash Cymbal	←	←	←	←	←	←	←	←	←
B1 55	Cowbell	←	←	←	←	←	←	←	←	←
C1 56	Crash Cymbal 2	←	←	←	←	←	←	←	←	←
D1 57	Ride Cymbal 2	←	←	←	←	←	←	←	←	←
E1 58	Vibraslap	←	←	←	←	←	←	←	←	←
F1 59	High Bongo	←	←	←	←	←	←	←	←	←
G1 60	Low Bongo	←	←	←	←	←	←	←	←	←
A1 61	Mute High Conga	←	←	←	←	←	←	←	←	←
B1 62	Open High Conga	←	←	←	←	←	←	←	←	←
C1 63	Open Low Conga	←	←	←	←	←	←	←	←	←
D1 64	High Timbale	←	←	←	←	←	←	←	←	←
E1 65	Low Timbale	←	←	←	←	←	←	←	←	←
F1 66	High Agogo	←	←	←	←	←	←	←	←	←
G1 67	Low Agogo	←	←	←	←	←	←	←	←	←
A1 68	Cabasa	←	←	←	←	←	←	←	←	←
B1 69	Maracas	←	←	←	←	←	←	←	←	←
C1 70	Short High Whistle	←	←	←	←	←	←	←	←	←
D1 71	Long Low Whistle	←	←	←	←	←	←	←	←	←
E1 72	Short Guiro	←	←	←	←	←	←	←	←	←
F1 73	Long Guiro	←	←	←	←	←	←	←	←	←
G1 74	Claves	←	←	←	←	←	←	←	←	←
A1 75	High Wood Block	←	←	←	←	←	←	←	←	←
B1 76	Low Wood Block	←	←	←	←	←	←	←	←	←
C1 77	Mute Cuica	←	←	←	←	←	←	←	←	←
D1 78	Open Cuica	←	←	←	←	←	←	←	←	←
E1 79	Mute Triangle	←	←	←	←	←	←	←	←	←
F1 80	Open Triangle	←	←	←	←	←	←	←	←	←
G1 81	Shaker	←	←	←	←	←	←	←	←	←
A1 82	Jingle Bell	←	←	←	←	←	←	←	←	←
B1 83	Bell Tree	←	←	←	←	←	←	←	←	←
C1 84	Castanets	←	←	←	←	←	←	←	←	←
D1 85	Mute Surdo	←	←	←	←	←	←	←	←	←
E1 86	Open Surdo	←	←	←	←	←	←	←	←	←
F1 87	Applause 1	←	←	←	←	←	←	←	←	←
G1 88	Applause 2	←	←	←	←	←	←	←	←	←
A1 89	←	←	←	←	←	←	←	←	←	←

• “←” indicates a key is assigned the same tones as it is for STANDARD SET.

DSP Effect List

The table below shows the DSP types that can be configured for each zone using zone parameters (page E-28).

- The “DSP No.” column shows the DSP type numbers that appear on page 3 of the zone menu, and “Screen Name” shows the name (abbreviated) that appears on the screen. “DSP Name” shows the full version of the screen name.
- For information about the parameters of a DSP type, note the value for it shown in the “Algorithm No.” column, and then refer to the corresponding item in the DSP Algorithm List (pages E-61 to E-66). Also note that algorithms 01 through 17 are single effects, while numbers with M before them are multi effects.
- The following two parameters are common to all of the DSP types in the table below.

Reverb Send (0 to 127)

Specifies how much of the sound that passes the DSP is sent to reverb.

Chorus Send (0 to 127)

Specifies how much of the sound that passes the DSP is sent to chorus.

DSP No.	Screen Name	DSP Name	Algorithm No.
Dynamics Fx			
[1]	Equalizer	Equalizer	01
[2]	Compressor 1	Compressor 1	02
[3]	Compressor 2	Compressor 2	02
[4]	Limiter	Limiter	03
[5]	Enhancer	Enhancer	04
[6]	Comp-Enhancer	Compressor - Enhancer	M03
Reflection			
[7]	Reflection	Reflection	07
Phaser			
[8]	Phaser 1	Phaser 1	12
[9]	Phaser 2	Phaser 2	12
[10]	Phaser 3	Phaser 3	13
[11]	Comp-Phaser	Compressor - Phaser	M17
Chorus/Flanger			
[12]	Chorus 1	Chorus 1	05
[13]	Chorus 2	Chorus 2	05
[14]	Chorus 3	Chorus 3	10
[15]	Flanger	Flanger	17
[16]	Comp-Chorus	Compressor - Chorus	M04
[17]	Enha-Chorus 1	Enhancer - Chorus 1	M01
[18]	Enha-Chorus 2	Enhancer - Chorus 2	M01
Pha/Cho/Flanger Combination			
[19]	Phaser-Chorus 1	Phaser - Chorus 1	M05
[20]	Phaser-Chorus 2	Phaser - Chorus 2	M05
[21]	Chorus-Flan 1	Chorus - Flanger 1	M07
[22]	Chorus-Flan 2	Chorus - Flanger 2	M07
Pan/Tremolo Fx			
[23]	Tremolo	Tremolo	06
[24]	Chorus-Tremolo	Chorus - Tremolo	M02
[25]	Comp-Tremolo	Compressor - Tremolo	M16
[26]	Dist-Tremolo	Distortion - Tremolo	M14
[27]	Auto Pan	Auto Pan	11
[28]	Comp-Auto Pan	Compressor - Auto Pan	M15
[29]	Dist-Auto Pan	Distortion - Auto Pan	M13
[30]	Phaser-APan 1	Phaser - Auto Pan 1	M06
[31]	Phaser-APan 2	Phaser - Auto Pan 2	M06
[32]	Pha-Cho-AutoPan	Phaser - Chorus - Auto Pan	M19
Rotary Fx			
[33]	Rotary 1	Rotary 1	08
[34]	Rotary 2	Rotary 2	08
[35]	Od Rotary 1	Overdrive Rotary 1	09
[36]	Od Rotary 2	Overdrive Rotary 2	09

DSP No.	Screen Name	DSP Name	Algorithm No.
Wah Fx			
[37]	LFO Wah	LFO Wah	16
[38]	Auto Wah	Auto Wah	15
[39]	Comp-LFO Wah	Compressor - LFO Wah	M12
[40]	Comp-Auto Wah	Compressor - Auto Wah	M11
[41]	LFO Wah-Chorus	LFO Wah - Chorus	M20
[42]	Auto Wah-Cho 1	Auto Wah - Chorus 1	M21
[43]	Auto Wah-Cho 2	Auto Wah - Chorus 2	M21
[44]	Auto Wah-Phaser	Auto Wah - Phaser	M08
Distortion Fx			
[45]	Crunch	Crunch	14
[46]	Overdrive	Overdrive	14
[47]	Distortion	Distortion	14
[48]	Phaser-Dist	Phaser - Distortion	M18
[49]	Crunch-Phaser	Crunch - Phaser	M09
[50]	Ovrdrive-Phaser	Overdrive - Phaser	M09
[51]	Crunch-Chorus	Crunch - Chorus	M10
[52]	Ovrdrive-Chorus	Overdrive - Chorus	M10
[53]	Dist-Chorus 1	Distortion - Chorus 1	M10
[54]	Dist-Chorus 2	Distortion - Chorus 2	M10
[55]	Comp-Dist-Cho 1	Compressor - Distortion - Chorus 1	M22
[56]	Comp-Dist-Cho 2	Compressor - Distortion - Chorus 2	M22
[57]	LWah-Dist-Cho 1	LFO Wah - Distortion - Chorus 1	M23
[58]	LWah-Dist-Cho 2	LFO Wah - Distortion - Chorus 2	M23
[59]	AWah-Dist-Cho 1	Auto Wah - Distortion - Chorus 1	M24
[60]	AWah-Dist-Cho 2	Auto Wah - Distortion - Chorus 2	M24
[61]	Cmp-Dist-APan 1	Compressor - Distortion - Auto Pan 1	M25
[62]	Cmp-Dist-APan 2	Compressor - Distortion - Auto Pan 2	M25
[63]	Cmp-Dist-Trem 1	Compressor - Distortion - Tremolo 1	M26
[64]	Cmp-Dist-Trem 2	Compressor - Distortion - Tremolo 2	M26

DSP Algorithm List

Single-effect Algorithms

01: Equalizer

This is a three-band equalizer.

Parameter Value Ranges:

- 0 :Equalizer 1 Frequency (1.0, 1.3, 1.6, 2.0, 2.5, 3.2, 4.0, 5.0 [KHz])
Adjusts the center frequency of Equalizer 1.
- 1 :Equalizer 1 Gain (-12 to 0 to +12)
Adjusts the gain of Equalizer 1.
- 2 :Equalizer 2 Frequency (1.0, 1.3, 1.6, 2.0, 2.5, 3.2, 4.0, 5.0 [KHz])
Adjusts the center frequency of Equalizer 2.
- 3 :Equalizer 2 Gain (-12 to 0 to +12)
Adjusts the gain of Equalizer 2.
- 4 :Equalizer 3 Frequency (1.0, 1.3, 1.6, 2.0, 2.5, 3.2, 4.0, 5.0 [KHz])
Adjusts the center frequency of Equalizer 3.
- 5 :Equalizer 3 Gain (-12 to 0 to +12)
Adjusts the gain of Equalizer 3.

Note: The Gain value is not a dB value.

02: Compressor

Compresses the input signal, which can have the effect of suppressing level variation and making it possible to sustain dampened sounds longer.

Parameter Value Ranges:

- 0 :Depth (0 to 127)
Adjusts compression of the audio signal.
- 1 :Attack (0 to 127)
Adjusts the attack amount of the input signal. A smaller value causes prompt compressor operation, which suppresses the attack of the input signal. A larger values delays compressor operation, which causes the attack of the input signal to be output as-is.
- 2 :Release (0 to 127)
Adjusts the time from the point the input signal drops below a certain level until the compression operation is stopped. When an attack feeling is desired (no compression at the onset of sound), set this parameter to as low a value as possible. To have compression applied at all times, set a high value.
- 3 :Level (0 to 127)
Adjusts the output level.
Output volume changes in accordance with the Depth setting and the characteristics of the input tone. Use this parameter to correct for such changes.

03: Limiter

Limits the input signal level so it does not rise above a preset level.

Parameter Value Ranges:

- 0 :Limit (0 to 127)
Adjusts the volume level of the limit at which limiting is applied.
- 1 :Attack (0 to 127)
Adjusts the attack amount of the input signal.
- 2 :Release (0 to 127)
Adjusts the time from the point the input signal drops below a certain level until the limit operation is stopped.
- 3 :Level (0 to 127)
Adjusts the output level.
Output volume changes in accordance with the Limit setting and the characteristics of the input tone. Use this parameter to correct for such changes.

04: Enhancer

Enhances the profiles of the low range and high range of the input signal.

Parameter Value Ranges:

- 0 :Low Frequency (0 to 127)
Adjusts the low range enhancer frequency.
- 1 :Low Gain (0 to 127)
Adjusts the low range enhancer gain.
- 2 :High Frequency (0 to 127)
Adjusts the high range enhancer frequency.
- 3 :High Gain (0 to 127)
Adjusts the high range enhancer gain.

05: Chorus

This is a stereo chorus effect using a sine wave LFO.

Parameter Value Ranges:

- 0 :LFO Rate (0 to 127)
Adjusts the LFO rate.
- 1 :LFO Depth (0 to 127)
Adjusts the LFO depth.
- 2 :Feedback (-64 to 0 to +63)
Adjusts the strength of feedback
- 3 :Wet Level (0 to 127)
Adjusts the level of the effect sound.
- 4 :Polarity (-, +)
Reverses the LFO signal of one channel, which changes the expanse of sound.

06: Tremolo

Adjusts the volume of the input signal using an LFO.

Parameter Value Ranges:

- 0 :Rate (0 to 127)
Adjusts the tremolo rate.
- 1 :Depth (0 to 127)
Adjusts the tremolo depth.

07: Early Reflection

Extracts the initial reflection sound from reverberation sound.

Parameter Value Ranges:

- 0 :Wet Level (0 to 127)
Adjusts the level of the effect sound.
- 1 :Feedback (0 to 127)
Adjusts the repeat of the reflected sound.
- 2 :Tone (0 to 127)
Adjusts the tone of the reflected sound.

08: Rotary

This is a rotary speaker simulator.

Parameter Value Ranges:

- 0 :Speed (Slow, Fast)
Switches the speed mode between fast and slow.
- 1 :Brake (Rotate, Stop)
Stops speaker rotation.
- 2 :Fall Acceleration (0 to 127)
Adjusts acceleration when the speed mode is switched from fast to slow.
- 3 :Rise Acceleration (0 to 127)
Adjusts acceleration when the speed mode is switched from slow to fast.
- 4 :Slow Rate (0 to 127)
Adjusts the speaker rotation speed in the slow speed mode.
- 5 :Fast Rate (0 to 127)
Adjusts the speaker rotation speed in the fast speed mode.

09: Drive Rotary

This is an overdrive - rotary speaker simulator.

Parameter Value Ranges:

- 0 :Overdrive Gain (0 to 127)
Adjusts overdrive gain.
- 1 :Overdrive Level (0 to 127)
Adjusts the overdrive output level.
- 2 :Speed (Slow, Fast)
Switches the speed mode between fast and slow.
- 3 :Brake (Rotate, Stop)
Stops speaker rotation.
- 4 :Fall Acceleration (0 to 127)
Adjusts acceleration when the speed mode is switched from fast to slow.
- 5 :Rise Acceleration (0 to 127)
Adjusts acceleration when the speed mode is switched from slow to fast.
- 6 :Slow Rate (0 to 127)
Adjusts the speaker rotation speed in the slow speed mode.
- 7 :Fast Rate (0 to 127)
Adjusts the speaker rotation speed in the fast speed mode.

10: 3-Phase Chorus

This is a 3-phase chorus effect using two LFOs with different sine wave rates.

Parameter Value Ranges:

- 0 :Rate 1 (Fast LFO State) (0 to 127)
Adjusts the rate of LFO 1.
- 1 :Depth 1 (Fast LFO Depth) (0 to 127)
Adjusts the depth of LFO 1.
- 2 :Rate 2 (Slow LFO State) (0 to 127)
Adjusts the rate of LFO 2.
- 3 :Depth 2 (Slow LFO Depth) (0 to 127)
Adjusts the depth of LFO 2.
- 4 :Wet Level (0 to 127)
Adjusts the level of the effect sound.

11: Auto Pan

Performs continual left-right panning of the input signal using an LFO.

Parameter Value Ranges:

- 0 :Rate (0 to 127)
Adjusts the panning rate.
- 1 :Depth (0 to 127)
Adjusts the panning depth.

12: Stereo Phaser

This is a stereo phaser that modulates the phase using a sine wave LFO.

Parameter Value Ranges:

- 0 :Resonance (0 to 127)
Adjusts the strength of the resonance.
- 1 :Manual (-64 to 0 to +63)
Adjusts the reference phaser shift amount.
- 2 :Rate (0 to 127)
Adjusts the LFO rate.
- 3 :Depth (0 to 127)
Adjusts the LFO depth.
- 4 :Wet Level (0 to 127)
Adjusts the level of the effect sound.

13: Phaser

This is a monaural phaser that modulates the phase using a sine wave LFO.

Parameter Value Ranges:

- 0 :Resonance (0 to 127)
Adjusts the strength of the resonance.
- 1 :Manual (-64 to 0 to +63)
Adjusts the reference phaser shift amount.
- 2 :Rate (0 to 127)
Adjusts the LFO rate.
- 3 :Depth (0 to 127)
Adjusts the LFO depth.
- 4 :Wet Level (0 to 127)
Adjusts the level of the effect sound.

14: Distortion

This effect provides Distortion + Amp Simulator.

Parameter Value Ranges:

- 0 :Gain (0 to 127)
Adjusts the input signal gain.
- 1 :Low (0 to 127)
Adjusts the low-range gain.
The cutoff frequency depends on the DSP type.
- 2 :High (0 to 127)
Adjusts the high gain.
The cutoff frequency depends on the DSP type.
- 3 :Level (0 to 127)
Adjusts the output level.

15: Auto Wah

This is a “wah” effect that can automatically shift the frequency in accordance with the level of the input signal.

Parameter Value Ranges:

- 0 :Input Level (0 to 127)
Adjusts the input level. The input signal can become distorted when the level of the sound being input, the number of chords, or the Resonance value is large. Adjust this parameter to eliminate such distortion.
- 1 :Resonance (0 to 127)
Adjusts the strength of resonance.
- 2 :Manual (0 to 127)
Adjusts the wah filter reference frequency.
- 3 :Depth (-64 to 0 to +63)
Adjusts the depth of the wah in accordance with the level of the input signal.
Setting a positive value causes the wah filter to open in direct proportion with the level of the input signal, producing a bright sound. Setting a negative value causes the wah filter to close in direct proportion with the level of the input signal, producing a dark sound. Even when the wah filter is closed, high level input will cause it to reopen.

16: LFO Wah

This is a “wah” effect that can automatically affect the frequency using an LFO.

Parameter Value Ranges:

- 0 :Input Level (0 to 127)
Adjusts the input level. The input signal can become distorted when the level of the sound being input, the number of chords, or the Resonance value is large. Adjust this parameter to eliminate such distortion.
- 1 :Resonance (0 to 127)
Adjusts the strength of resonance.
- 2 :Manual (0 to 127)
Adjusts the wah filter reference frequency.
- 3 :LFO Rate (0 to 127)
Adjusts the LFO rate.
- 4 :LFO Depth (0 to 127)
Adjusts the LFO depth.

17: Flanger

This is a flanger that uses a sine wave LFO.

Parameter Value Ranges:

- 0 :LFO Rate (0 to 127)
Adjusts the LFO rate.
- 1 :LFO Depth (0 to 127)
Adjusts the LFO depth.
- 2 :Feedback (-64 to 0 to +63)
Adjusts the strength of feedback
- 3 :Wet Level (0 to 127)
Adjusts the level of the effect sound.

Multi-effect Algorithms

A multi-effect is one connected to multiple single effects (page E-61).

“M01: Multi01 (Enhancer - Chorus)”, for example, is a multi-effect connected to two single effects: Enhancer and Chorus. The parameters included in a multi-effect algorithm are the same as the each of the connected single-effect algorithms. However, the following two parameters are specific to multi effects.

***** Skip (Off, On)**

This parameter is included in M05, M06 (Phaser Skip), M08 (Wah Skip), etc.

It makes it possible for one of the effects of a multi effect (such a Wah in the case of Wah Skip) to be bypassed. Turning this parameter on causes the corresponding effect to be bypassed.

Note that depending on whether *** Skip is On or Off, there may be some difference in the level of notes that pass through the multi effect. Whether or not the level difference occurs depends on the settings of the other parameters of the multi effect. Adjust the Level, Depth, and other parameters for the skipped effect as required.

Routing

This parameter is included in M11 and M12. It swaps the routing of the effect.

The following shows only the parameters of multi-effect algorithms (M01 through M26).

M01: Multi01 (Enhancer - Chorus)

- 0 :Enhancer Low Frequency
- 1 :Enhancer Low Gain
- 2 :Enhancer High Frequency
- 3 :Enhancer High Gain
- 4 :Chorus Rate
- 5 :Chorus Depth
- 6 :Chorus Feedback
- 7 :Chorus Wet Level

M02: Multi02 (Chorus - Tremolo)

- 0 :Chorus Rate
- 1 :Chorus Depth
- 2 :Chorus Feedback
- 3 :Chorus Wet Level
- 4 :Tremolo Rate
- 5 :Tremolo Depth
- 6 :Chorus Polarity

M03: Multi03 (Compressor - Enhancer)

- 0 :Compressor Depth
- 1 :Compressor Attack
- 2 :Compressor Release
- 3 :Compressor Level
- 4 :Enhancer Low Frequency
- 5 :Enhancer Low Gain
- 6 :Enhancer High Frequency
- 7 :Enhancer High Gain

M04: Multi04 (Compressor - Chorus)

- 0 :Compressor Depth
- 1 :Compressor Attack
- 2 :Compressor Release
- 3 :Compressor Level
- 4 :Chorus Rate
- 5 :Chorus Depth
- 6 :Chorus Feedback
- 7 :Chorus Wet Level
- 8 :Chorus Polarity

M05: Multi05 (Phaser - Chorus)

- 0 :Phaser Resonance
- 1 :Phaser Manual
- 2 :Phaser Rate
- 3 :Phaser Depth
- 4 :Phaser Wet Level
- 5 :Chorus Rate
- 6 :Chorus Depth
- 7 :Chorus Feedback
- 8 :Chorus Wet Level
- 9 :Chorus Polarity
- 10 :Phaser Skip

M06: Multi06 (Phaser - Auto Pan)

- 0 :Phaser Resonance
- 1 :Phaser Manual
- 2 :Phaser Rate
- 3 :Phaser Depth
- 4 :Phaser Wet Level
- 5 :Auto Pan Rate
- 6 :Auto Pan Depth
- 7 :Phaser Skip

M07: Multi07 (Chorus - Flanger)

- 0 :Chorus Rate
- 1 :Chorus Depth
- 2 :Chorus Feedback
- 3 :Chorus Wet Level
- 4 :Flanger Rate
- 5 :Flanger Depth
- 6 :Flanger Feedback
- 7 :Flanger Wet Level
- 8 :Chorus Polarity
- 9 :Flanger Polarity

M08: Multi08 (Auto Wah - Phaser)

- 0 :Wah Input Level
- 1 :Wah Resonance
- 2 :Wah Manual
- 3 :Wah Depth
- 4 :Phaser Resonance
- 5 :Phaser Manual
- 6 :Phaser Rate
- 7 :Phaser Depth
- 8 :Phaser Wet Level
- 9 :Wah Skip

M09: Multi09 (Distortion - Phaser)

- 0 :Distortion Gain
- 1 :Distortion Low
- 2 :Distortion High
- 3 :Distortion Level
- 4 :Phaser Resonance
- 5 :Phaser Manual
- 6 :Phaser Rate
- 7 :Phaser Depth
- 8 :Phaser Wet Level
- 9 :Distortion Skip

M10: Multi10 (Distortion - Chorus)

- 0 :Distortion Gain
- 1 :Distortion Low
- 2 :Distortion High
- 3 :Distortion Level
- 4 :Chorus Rate
- 5 :Chorus Depth
- 6 :Chorus Feedback
- 7 :Chorus Wet Level
- 8 :Chorus Polarity
- 9 :Distortion Skip

M11: Multi11 (Compressor - Auto Wah)

- 0 :Compressor Depth
- 1 :Compressor Attack
- 2 :Compressor Release
- 3 :Compressor Level
- 4 :Wah Input Level
- 5 :Wah Resonance
- 6 :Wah Manual
- 7 :Wah Depth
- 8 :Wah Skip
- 9 :Routing (C-W: Comp-Wah, W-C: Wah-Comp)

M12: Multi12 (Compressor - LFO Wah)

- 0 :Compressor Depth
- 1 :Compressor Attack
- 2 :Compressor Release
- 3 :Compressor Level
- 4 :Wah Input Level
- 5 :Wah Resonance
- 6 :Wah Manual
- 7 :Wah LFO Rate
- 8 :Wah LFO Depth
- 9 :Wah Skip
- 10 :Routing (C-W: Comp-Wah, W-C: Wah-Comp)

M13: Multi13 (Distortion - Auto Pan)

0 :Distortion Gain
 1 :Distortion Low
 2 :Distortion High
 3 :Distortion Level
 4 :Auto Pan Rate
 5 :Auto Pan Depth
 6 :Distortion Skip
 7 :Auto Pan Skip

M14: Multi14 (Distortion - Tremolo)

0 :Distortion Gain
 1 :Distortion Low
 2 :Distortion High
 3 :Distortion Level
 4 :Tremolo Rate
 5 :Tremolo Depth
 6 :Distortion Skip
 7 :Tremolo Skip

M15: Multi15 (Compressor - Auto Pan)

0 :Compressor Depth
 1 :Compressor Attack
 2 :Compressor Release
 3 :Compressor Level
 4 :Auto Pan Rate
 5 :Auto Pan Depth
 6 :Auto Pan Skip

M16: Multi16 (Compressor - Tremolo)

0 :Compressor Depth
 1 :Compressor Attack
 2 :Compressor Release
 3 :Compressor Level
 4 :Tremolo Rate
 5 :Tremolo Depth
 6 :Tremolo Skip

M17: Multi17 (Compressor - Phaser)

0 :Compressor Depth
 1 :Compressor Attack
 2 :Compressor Release
 3 :Compressor Level
 4 :Phaser Resonance
 5 :Phaser Manual
 6 :Phaser Rate
 7 :Phaser Depth
 8 :Phaser Wet Level
 9 :Phaser Skip

M18: Multi18 (Phaser - Distortion)

0 :Phaser Resonance
 1 :Phaser Manual
 2 :Phaser Rate
 3 :Phaser Depth
 4 :Phaser Wet Level
 5 :Distortion Gain
 6 :Distortion Low
 7 :Distortion High
 8 :Distortion Level
 9 :Phaser Skip

M19: Multi19 (Phaser - Chorus - Auto Pan)

0 :Phaser Resonance
 1 :Phaser Manual
 2 :Phaser Rate
 3 :Phaser Depth
 4 :Phaser Wet Level
 5 :Chorus Rate
 6 :Chorus Depth
 7 :Chorus Feedback
 8 :Chorus Wet Level
 9 :Auto Pan Rate
 10 :Auto Pan Depth

M20: Multi20 (LFO Wah - Chorus)

0 :Wah Input Level
 1 :Wah Resonance
 2 :Wah Manual
 3 :Wah LFO Rate
 4 :Wah LFO Depth
 5 :Chorus Rate
 6 :Chorus Depth
 7 :Chorus Feedback
 8 :Chorus Wet Level
 9 :Chorus Polarity

M21: Multi21 (Auto Wah - Chorus)

0 :Wah Input Level
 1 :Wah Resonance
 2 :Wah Manual
 3 :Wah Depth
 4 :Chorus Rate
 5 :Chorus Depth
 6 :Chorus Feedback
 7 :Chorus Wet Level
 8 :Chorus Polarity

M22: Multi22 (Compressor - Distortion - Chorus)

0 :Compressor Depth
 1 :Compressor Attack
 2 :Compressor Release
 3 :Compressor Level
 4 :Distortion Gain
 5 :Distortion Low
 6 :Distortion High
 7 :Distortion Level
 8 :Chorus Rate
 9 :Chorus Depth
 10 :Chorus Feedback
 11 :Chorus Wet Level
 12 :Chorus Polarity
 13 :Distortion Skip

M23: Multi23 (LFO Wah - Distortion - Chorus)

0 :Wah Input Level
1 :Wah Resonance
2 :Wah Manual
3 :Wah LFO Rate
4 :Wah LFO Depth
5 :Distortion Gain
6 :Distortion Low
7 :Distortion High
8 :Distortion Level
9 :Chorus Rate
10 :Chorus Depth
11 :Chorus Feedback
12 :Chorus Wet Level
13 :Chorus Polarity
14 :Distortion Skip

M24: Multi24 (Auto Wah - Distortion - Chorus)

0 :Wah Input Level
1 :Wah Resonance
2 :Wah Manual
3 :Wah Depth
4 :Distortion Gain
5 :Distortion Low
6 :Distortion High
7 :Distortion Level
8 :Chorus Rate
9 :Chorus Depth
10 :Chorus Feedback
11 :Chorus Wet Level
12 :Chorus Polarity
13 :Distortion Skip

M25: Multi25 (Compressor - Distortion - Auto Pan)

0 :Compressor Depth
1 :Compressor Attack
2 :Compressor Release
3 :Compressor Level
4 :Distortion Gain
5 :Distortion Low
6 :Distortion High
7 :Distortion Level
8 :Auto Pan Rate
9 :Auto Pan Depth
10 :Distortion Skip
11 :Auto Pan Skip

M26: Multi26 (Compressor - Distortion - Tremolo)

0 :Compressor Depth
1 :Compressor Attack
2 :Compressor Release
3 :Compressor Level
4 :Distortion Gain
5 :Distortion Low
6 :Distortion High
7 :Distortion Level
8 :Tremolo Rate
9 :Tremolo Depth
10 :Distortion Skip
11 :Tremolo Skip



This recycle mark indicates that the packaging conforms to the environmental protection legislation in Germany.

Esta marca de reciclaje indica que el empaquetado se ajusta a la legislación de protección ambiental en Alemania.

CASIO®